

Funkcionális genomikai módszerek: technológia és alkalmazás

MTA SZBK, Genetika Intézet
Funkcionális Genomika Laboratórium

Genetikai Tanszék, ELTE TTK, Budapest
2018.11.28.

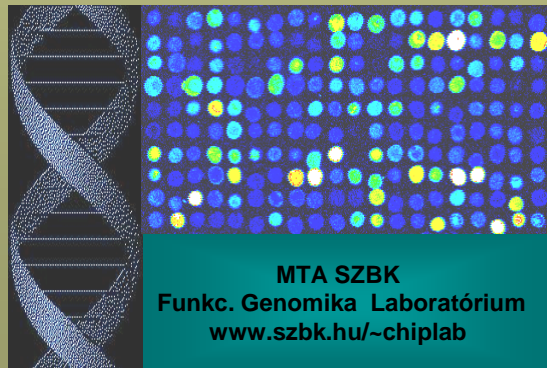

**Kromoszómák
genetikai állomány
hordozói**

sejt

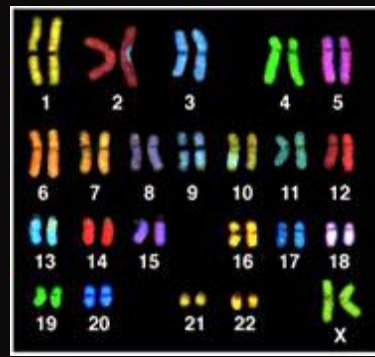

DNS

**Gének
információ hordozók**

mRNS

AAAAAA

AAAAAA

AAAAAA

**Fehérjék
sejtfunkciók
ellátása**

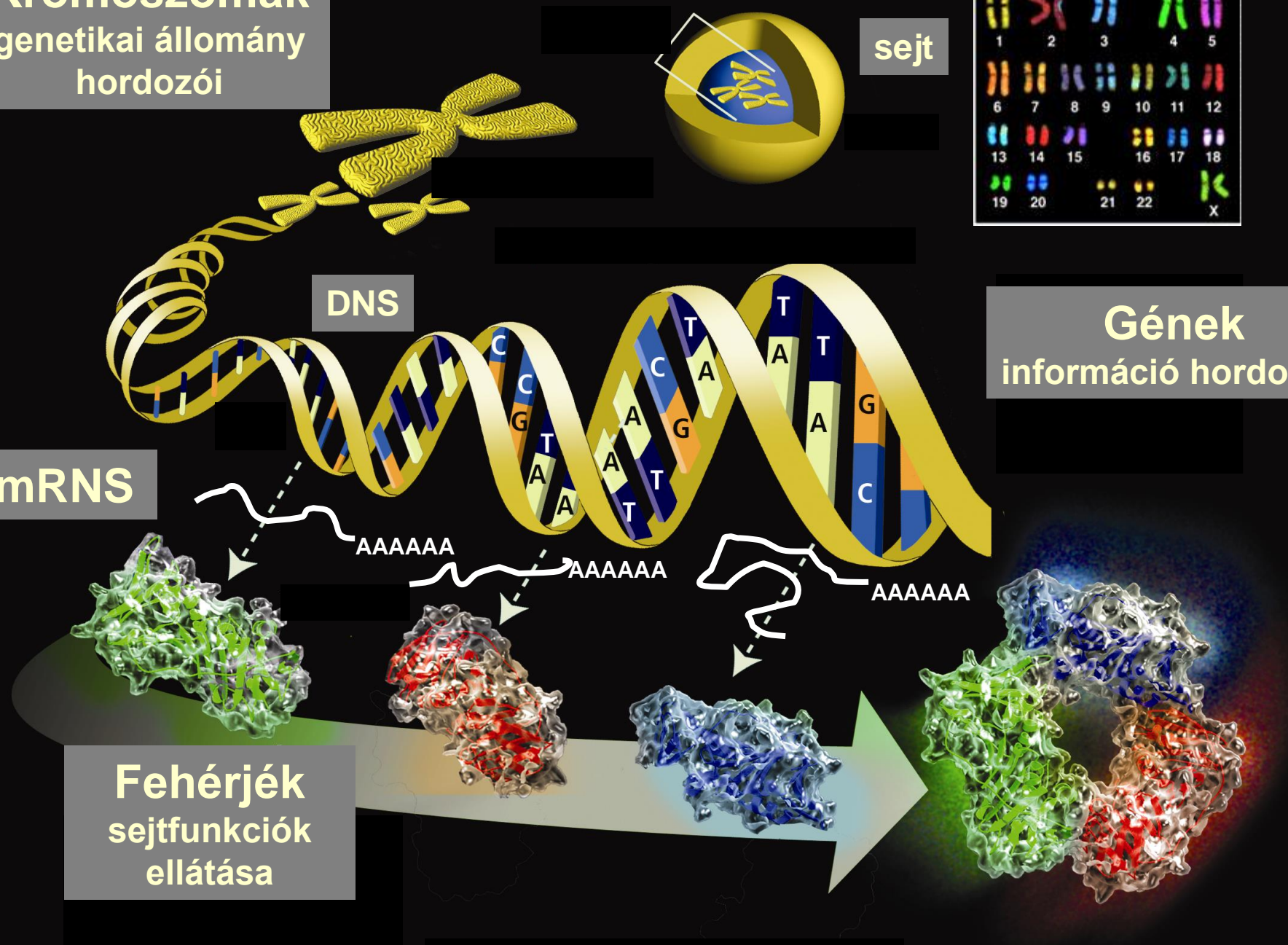

DNS metiláció és „hiszton-kód” – epigenetikai változások

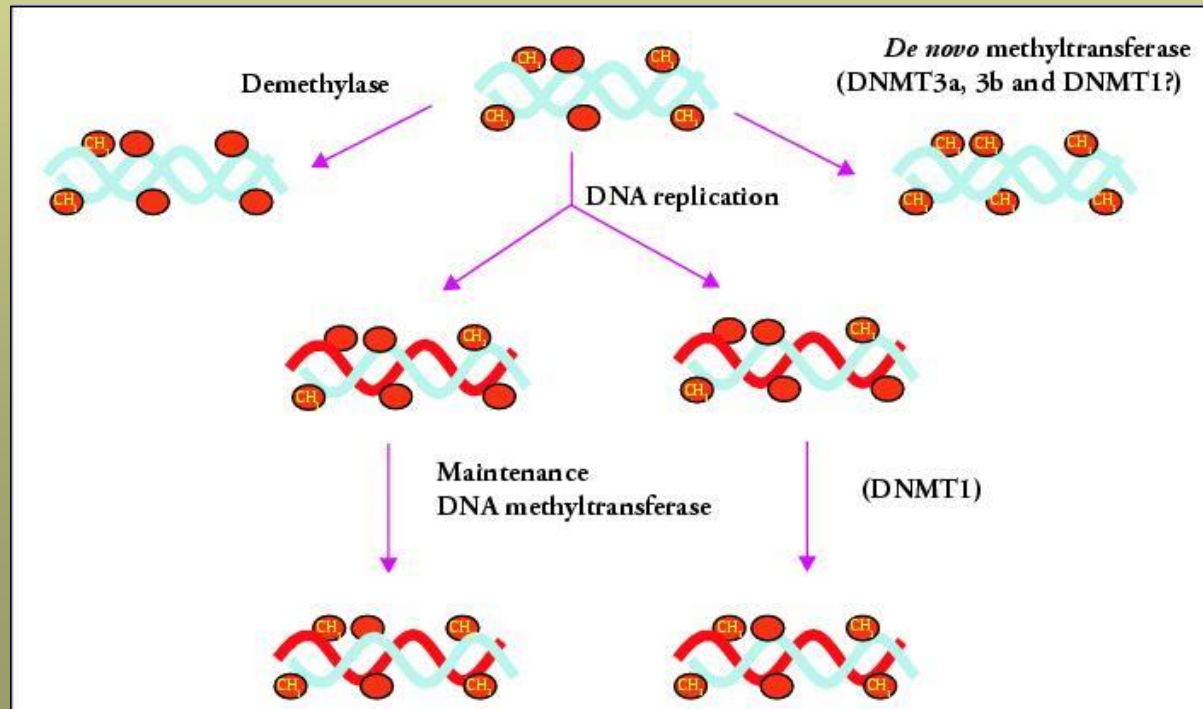
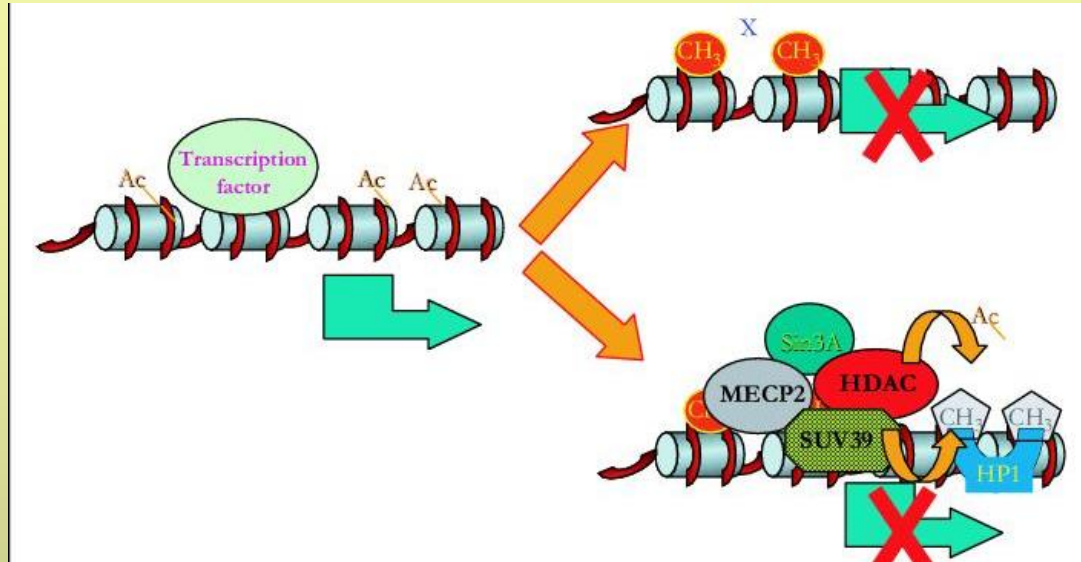

Repetitív szekvenciák – ártalmatlan „szemét”?

LINE
SINE

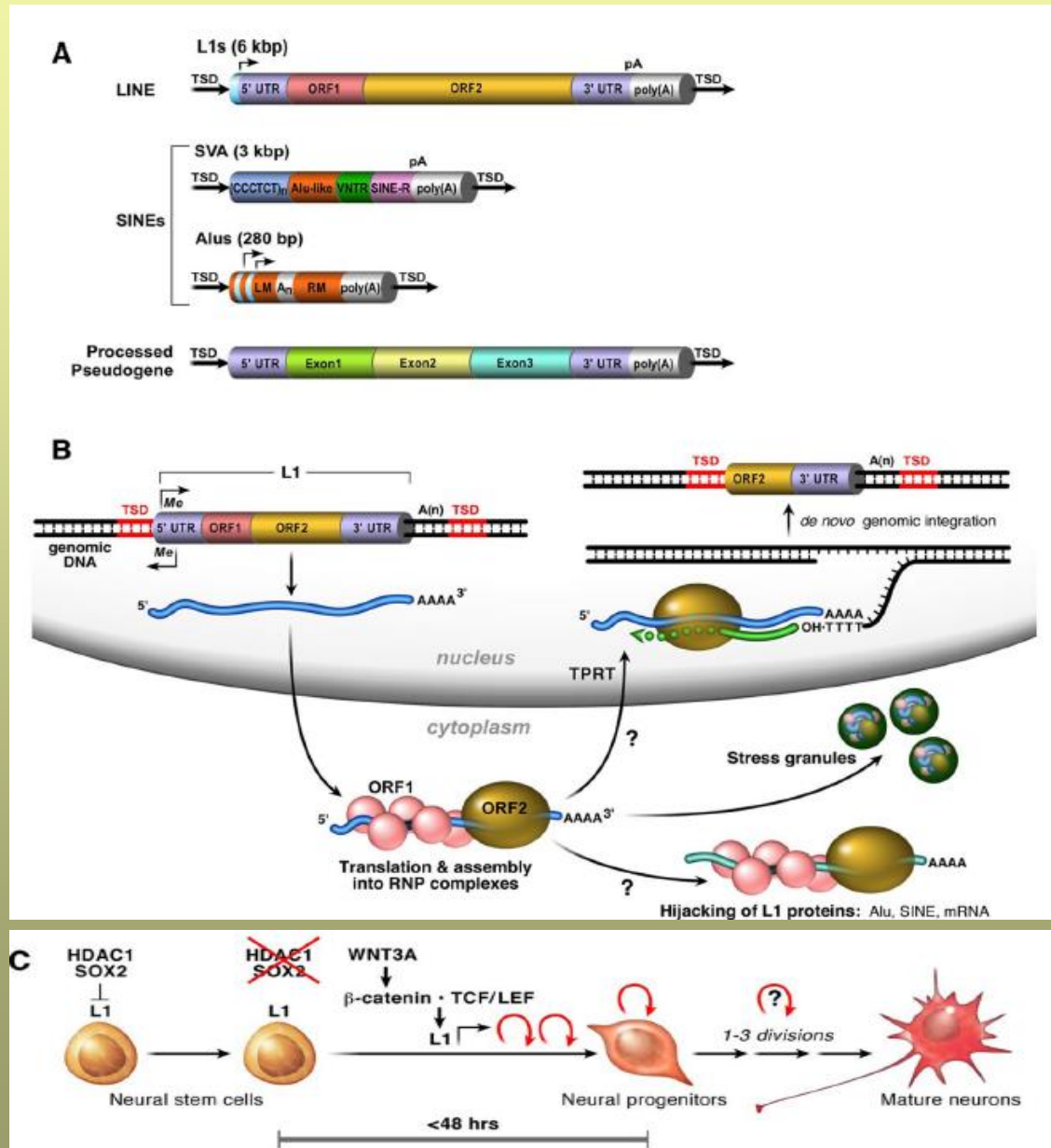

Repetitív szekvenciák – neuronális diverzitás oka?

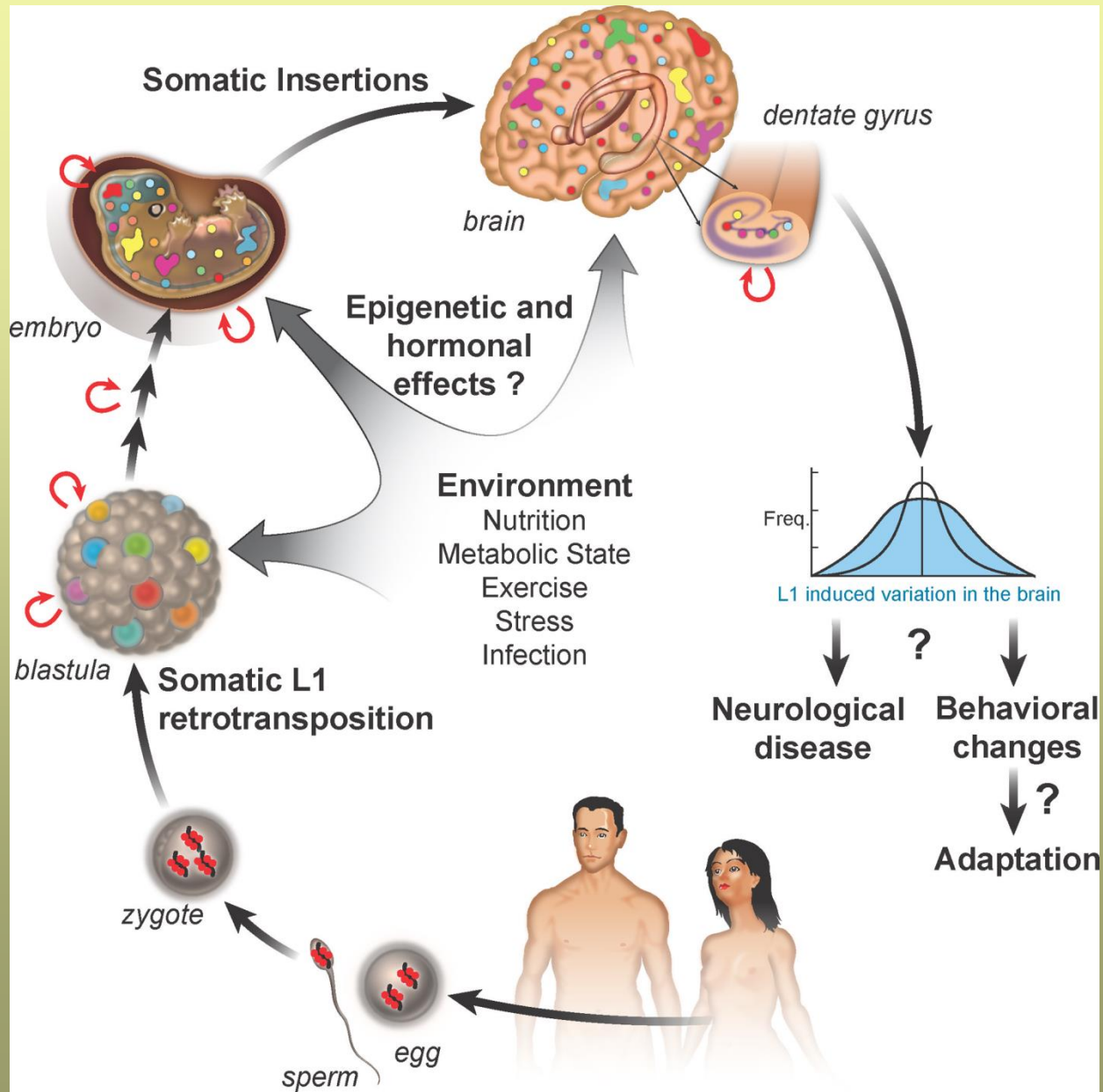

Molekuláris kapcsolók és hálózatok: a rendszerbiológia elemei

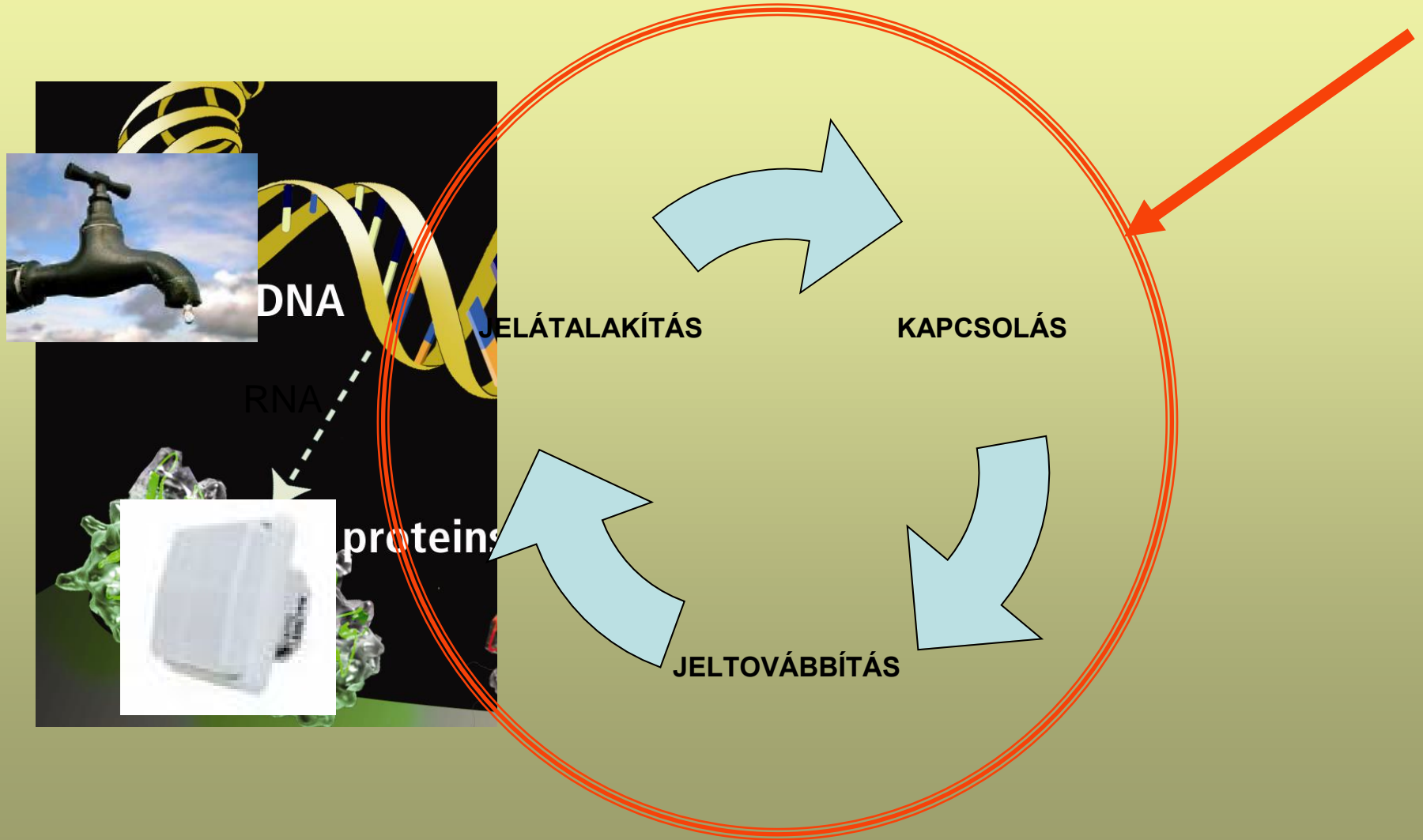

Kulcsszavak: kapcsolók

Molekuláris kapcsolók és hálózatok: a rendszerbiológia elemei

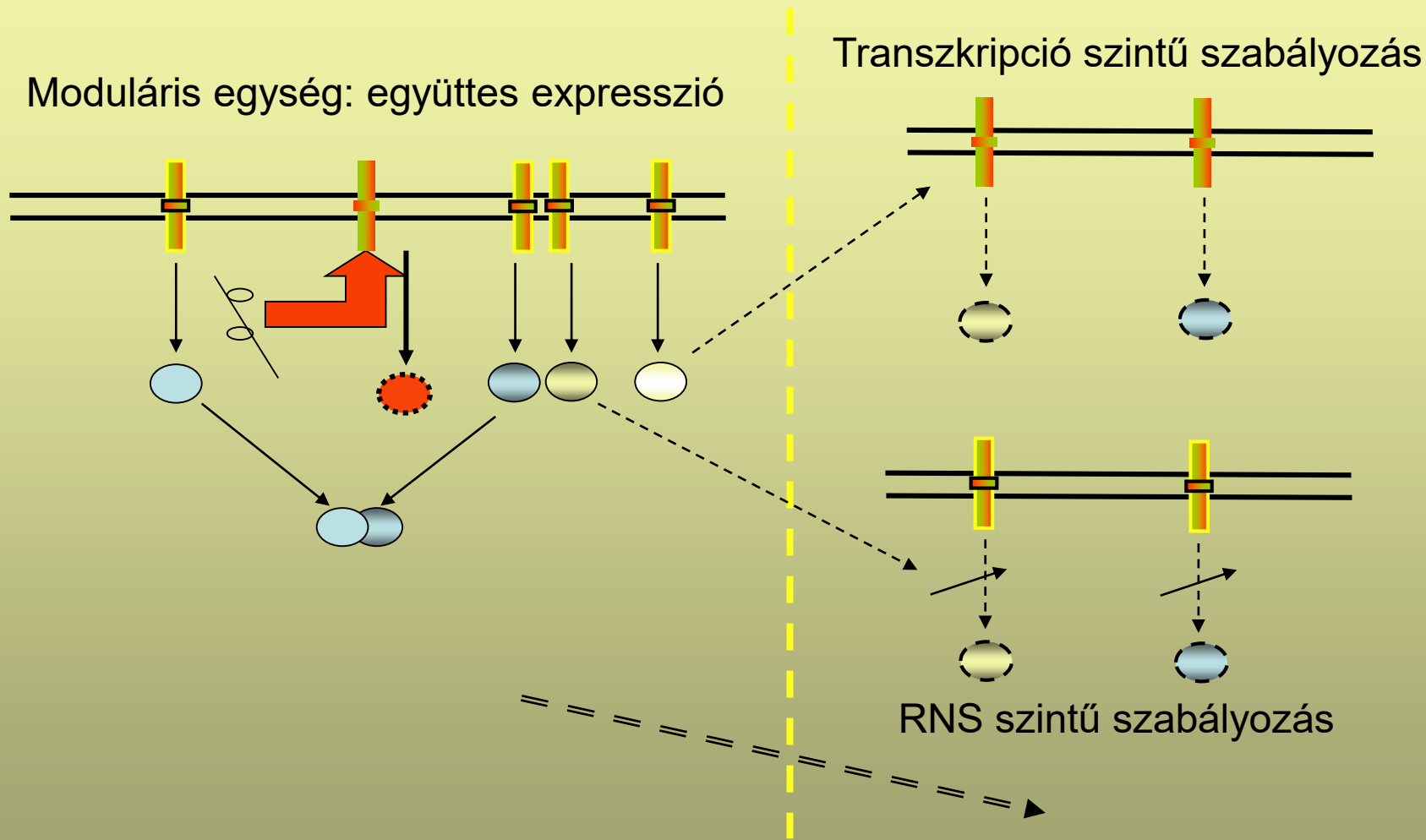

Kulcsszavak: kapcsolók és modulok

miRNS analízis

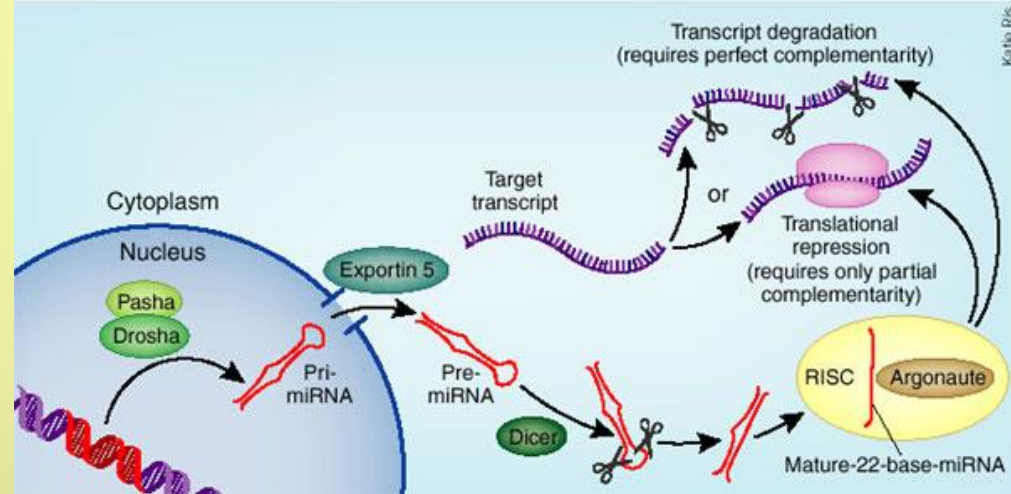

- miRNS: kis 19-25 nukleotid hosszú egyszálú RNS molekulák, amelyek a génexpresszió negatív szabályozásában játszanak szerepet
- a sejtmagban keletkeznek hosszú prekursor RNSként: *pri-miR*
- emberben számuk meghaladja az ezret -> minden miRNS több száz mRNA transzkripcióját szabályozza
- méretük és a nagyfokú szekvencia konzerváció (1-2 nukleotid eltérés) miatt detektálásuk nehéz
- megváltozott miRNS expresszió számos betegség kulcsa lehet -> target: rák, szív és érrendszeri megbetegedések

Génhálózatok, skála-független tulajdonság, redundancia és érzékenység

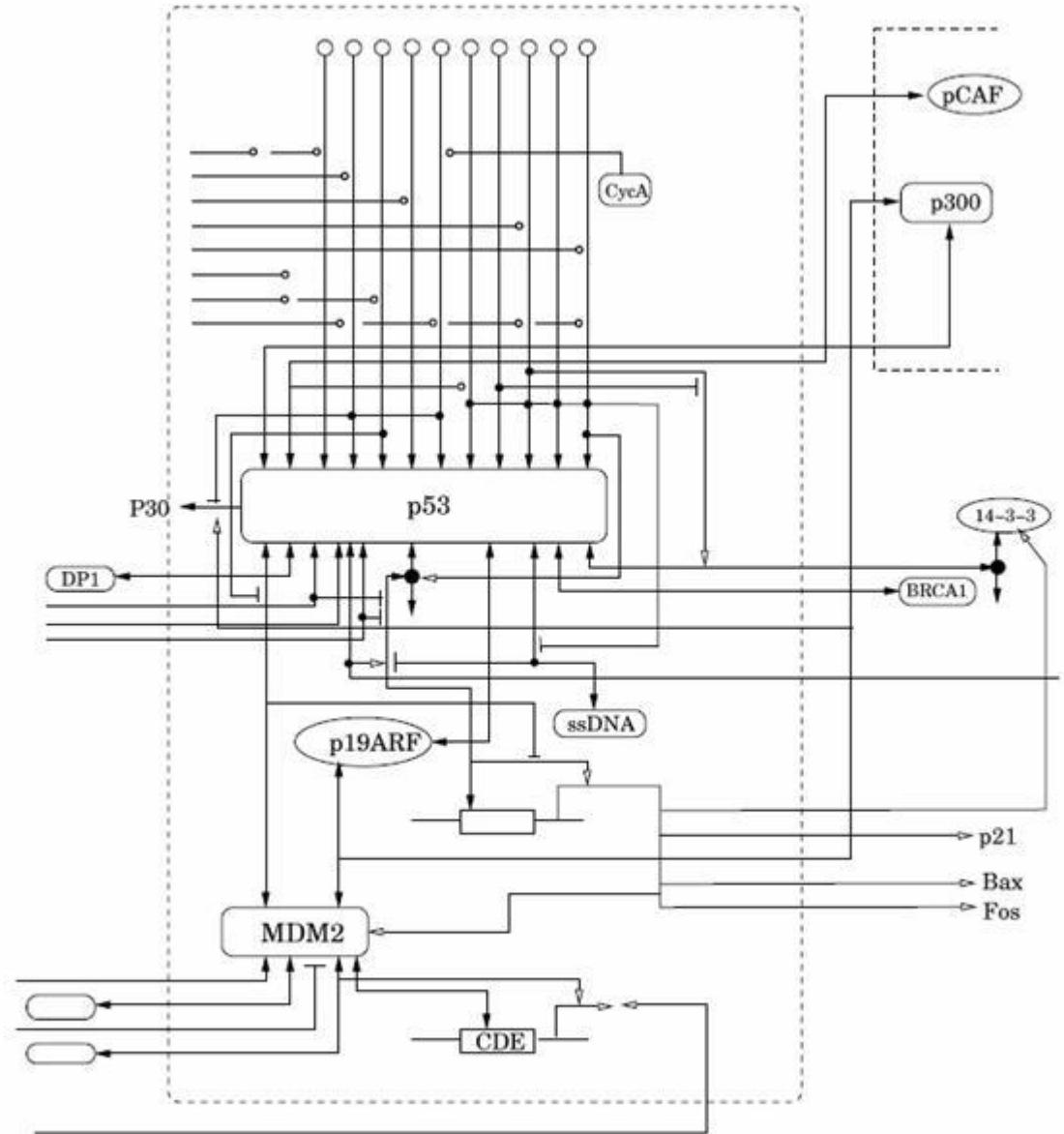
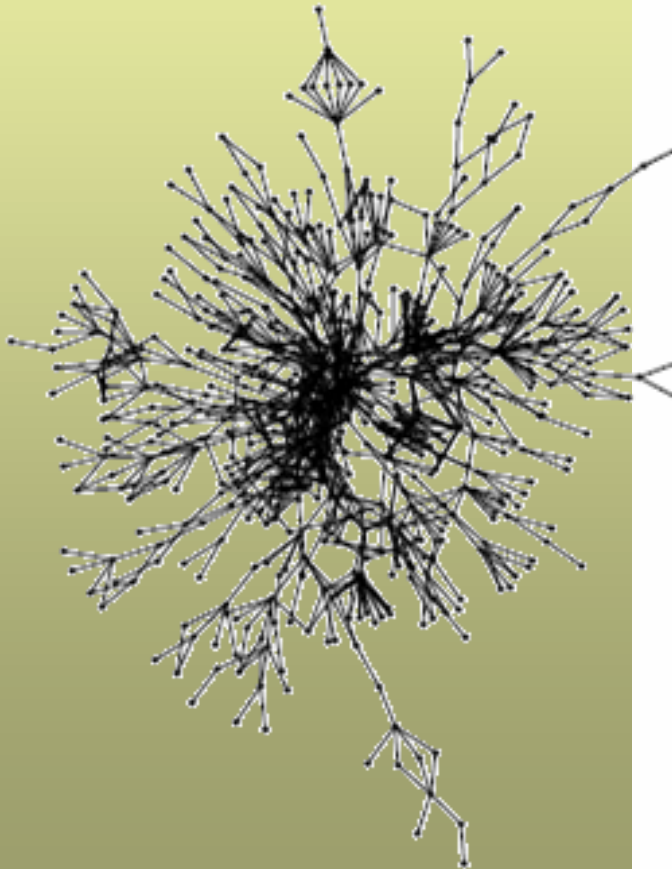
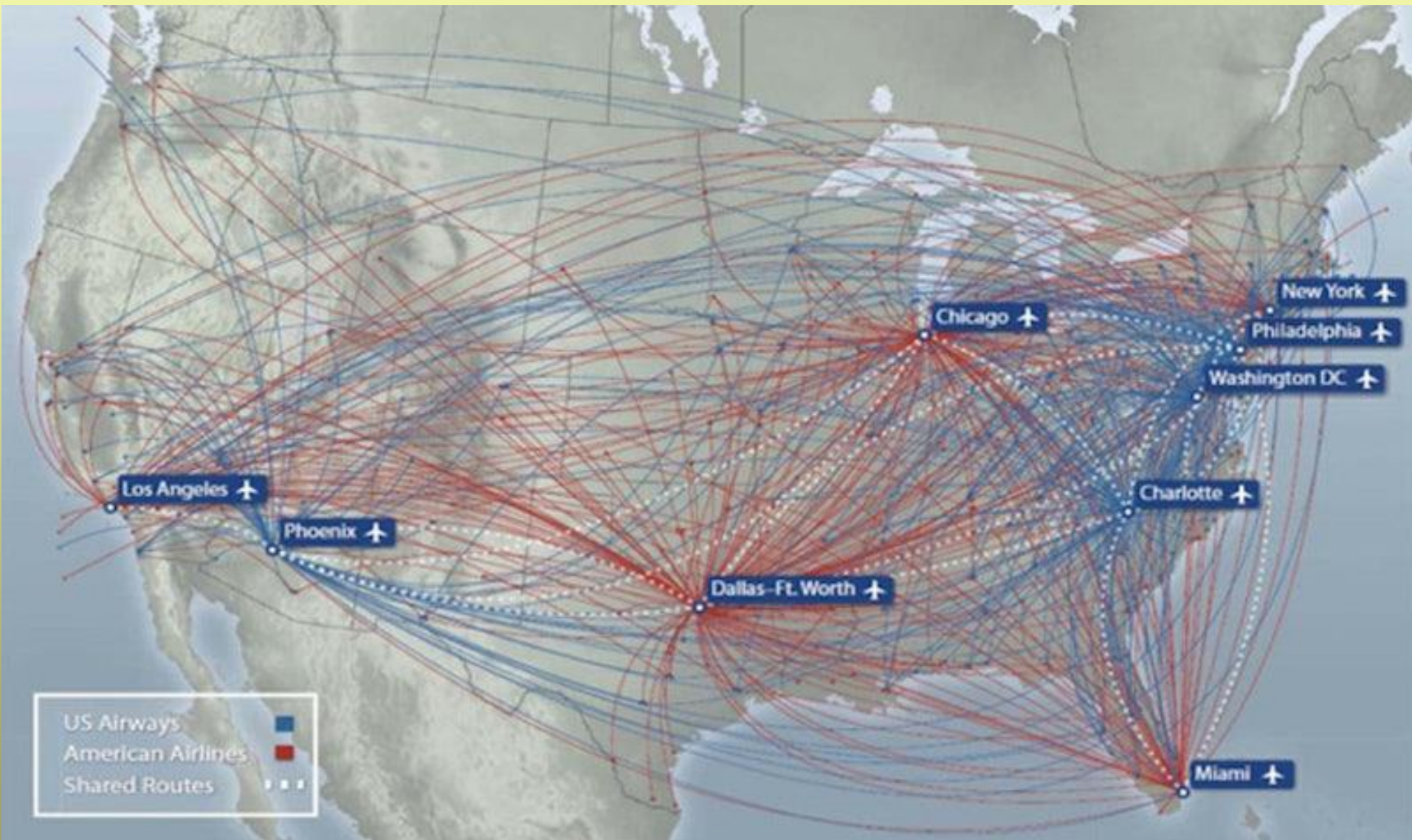

Figure 1.2: Schematic architecture of the p53 network. The p53 node integrates information from very different parts of the system. Only part of the cell circuitry is shown here. For a

Chicago nemzetközi célpontok, légvonal hálózat



Sejthálózatok és génhálózatok, kapcsolatok és jelek

Génaktivitás térbeli kifejeződése

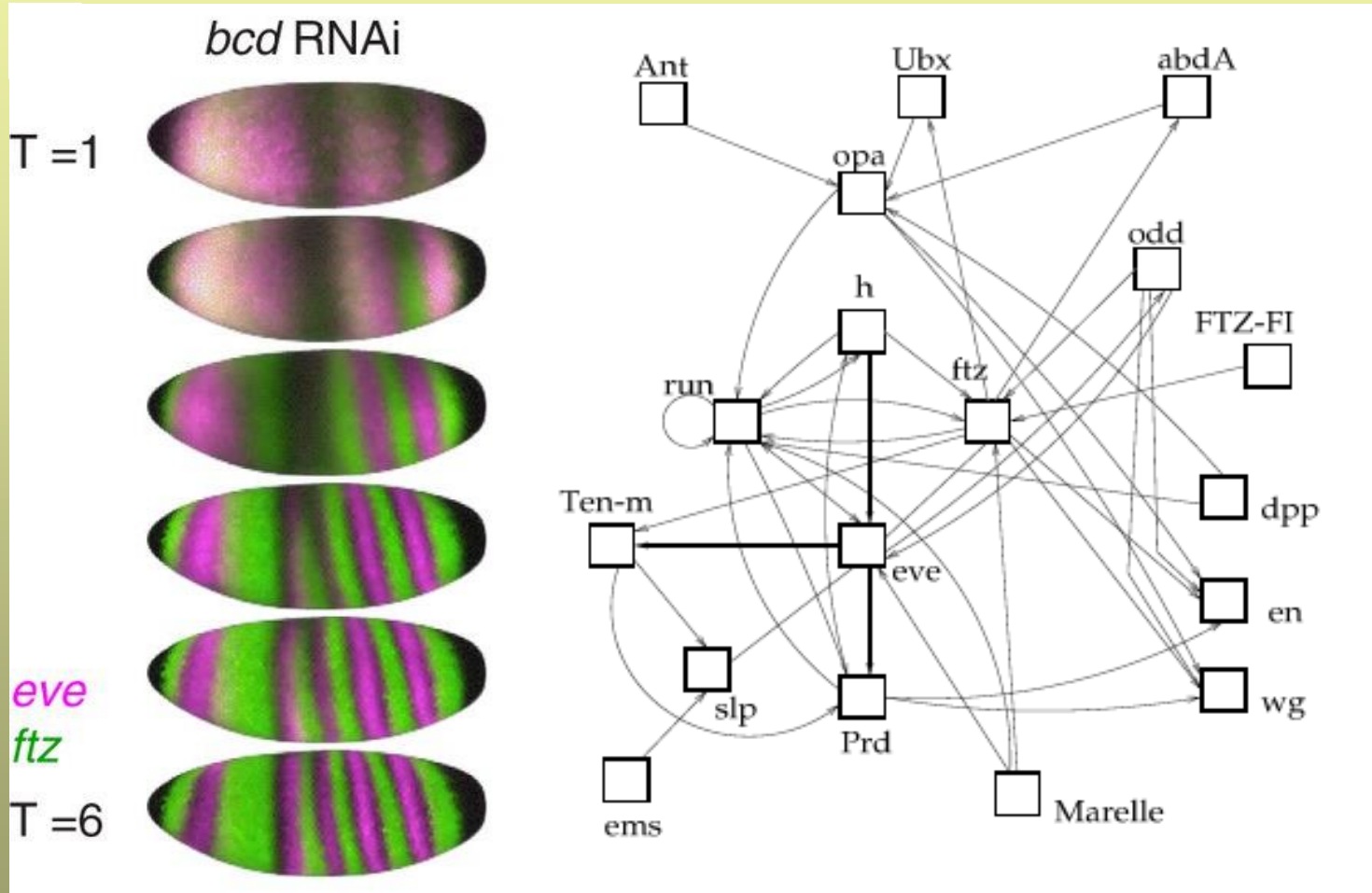

Ftz and eve are involved in the establishment of the segmentation pattern of the Drosophila embryo

A fenotípus meghatározója a transzkriptom vagy a genom?

Gurdon JB, Elsdale TR, Fischberg M (1958) Sexually mature individuals of *Xenopus laevis* from the transplantation of single somatic nuclei. *Nature* 182(4627):64–65.

Takahashi K, Yamanaka S (2006) Induction of pluripotent stem cells from mouse embryonic and adult fibroblast cultures by defined factors. *Cell* 126(4):663–676.

Sul JY, et al. (2009) Transcriptome transfer produces a predictable cellular phenotype. *Proc Natl Acad Sci USA* 106:7624–7629.

Kim TK, et al. (2011) Transcriptome transfer provides a model for understanding the phenotype of cardiomyocytes. *Proc Natl Acad Sci U S A*. 108(29):11918-23.

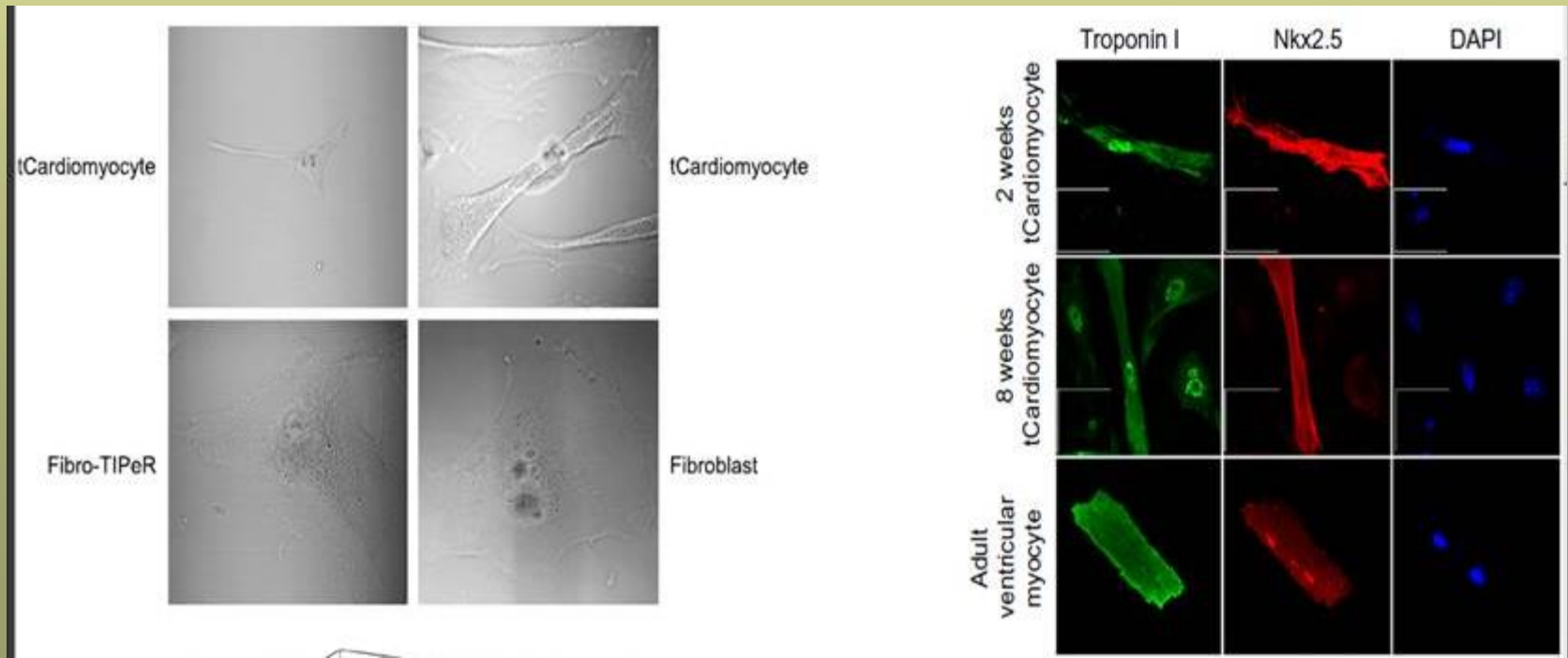

Sejtciklus-egyres fázisai

Ciklikus fehérje-módosítások, komplexek és degradációk

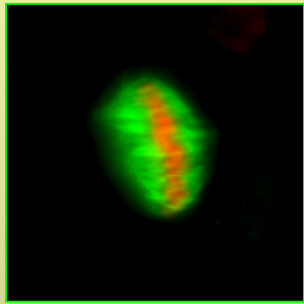

metaphase

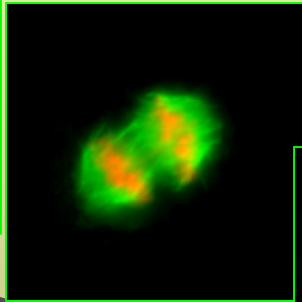

anaphase

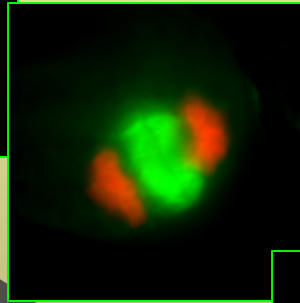

early telophase

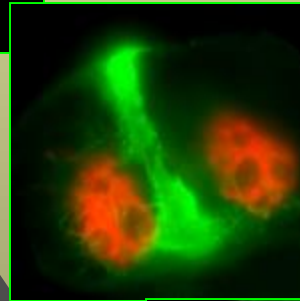

late telophase

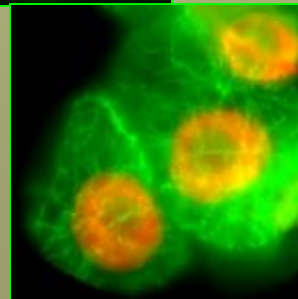

G1 phase

Funkcionális genomika lényege

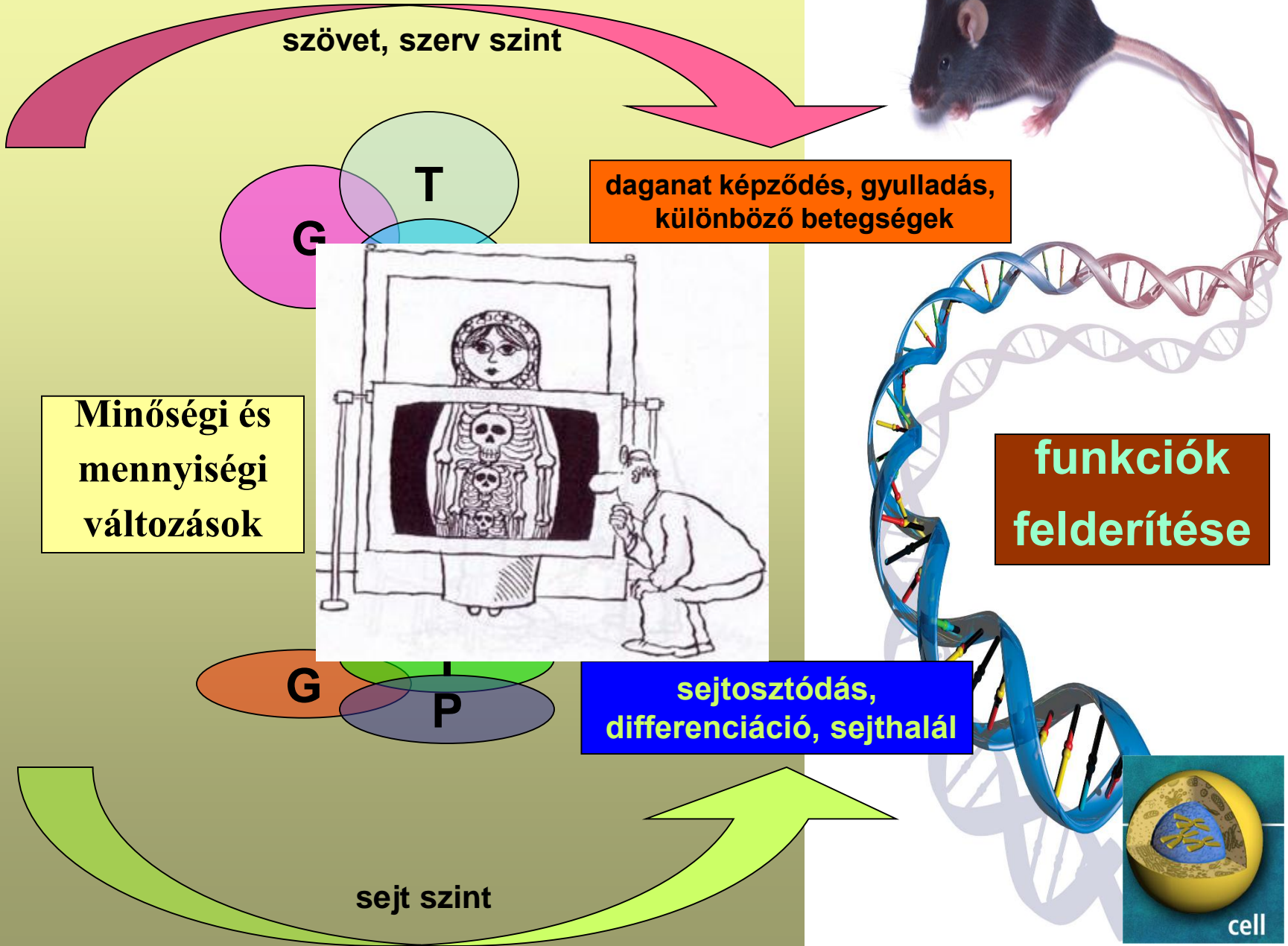

szövet, szerv szint

G

T

daganat képződés, gyulladás, különböző betegségek

Minőségi és mennyiségi változások

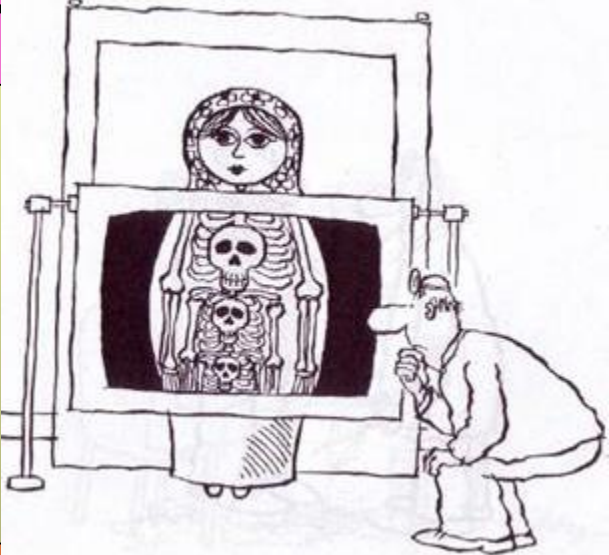

funkciók felderítése

G

T

P

sejtosztódás, differenciáció, sejthalál

sejt szint



cell

Microarray technológiák a funkcionális genomikában

Minta

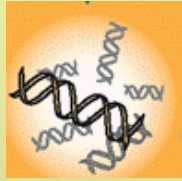

Fragmentek



Szubcelluláris



Sejtek



Szervek



Organizmusok



Közösségek

Cél-
molekula



DNS, RNS

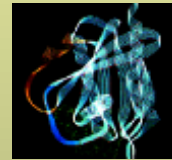

Fehérjék

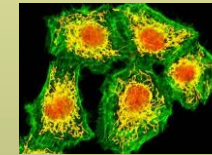

Sejtek

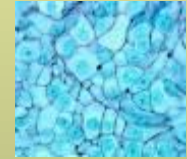

Szövetek

Microarray



Genomika

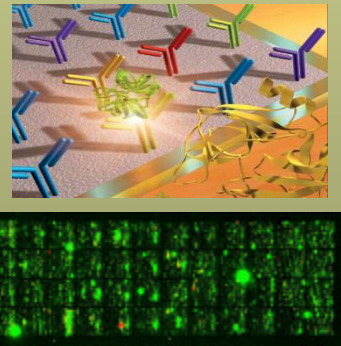

Proteomika

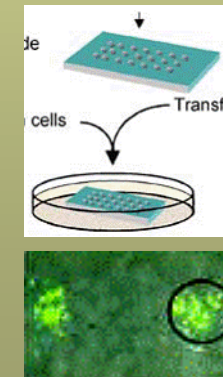

Citomika

A csipek hordozó szerinti osztályozása

macroarray

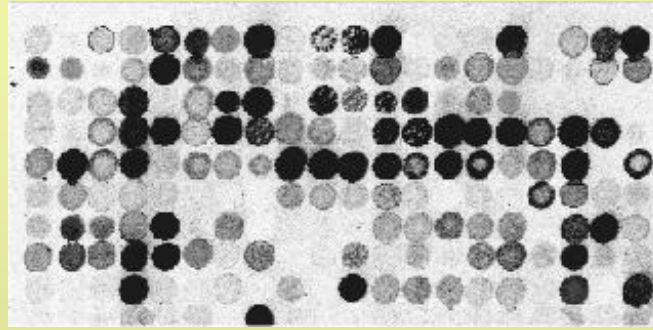

- nylon membránon néhány 100 génspecifikus minta (DNS darab)
- radioaktív jelölés
- kis minta sűrűség (100-1000 pont/cm²)

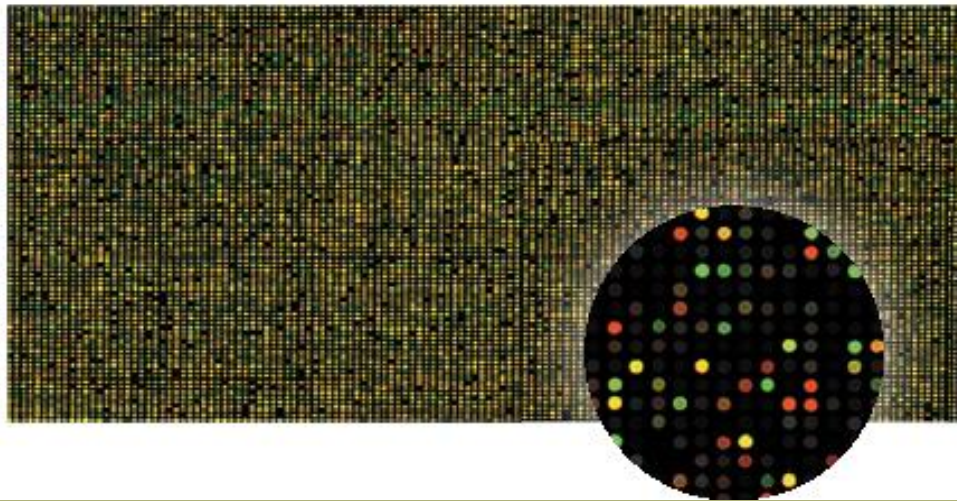

- üveglemezen több 10.000-100.000 génspecifikus minta (DNS darab)
- fluoreszcens jelölés
- közepes mintasűrűség (5000 pont/cm²)

chip

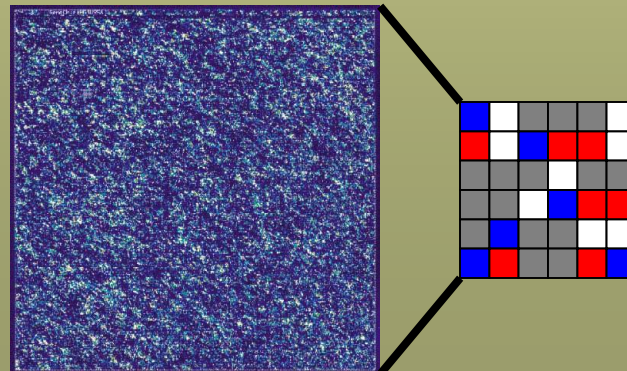

- üveglemezen több 100.000-1.000.000 génspecifikus minta (DNS darab)
- fluoreszcens jelölés
- nagy minta sűrűség (10.000 pont/cm²)

Alternatív technológiák oligonukleotid DNS-chipek gyártására

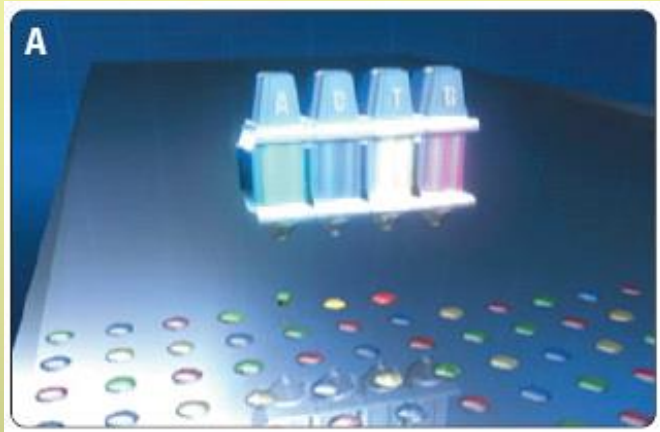

inkjet-printed microarrays
(e.g. Agilent)

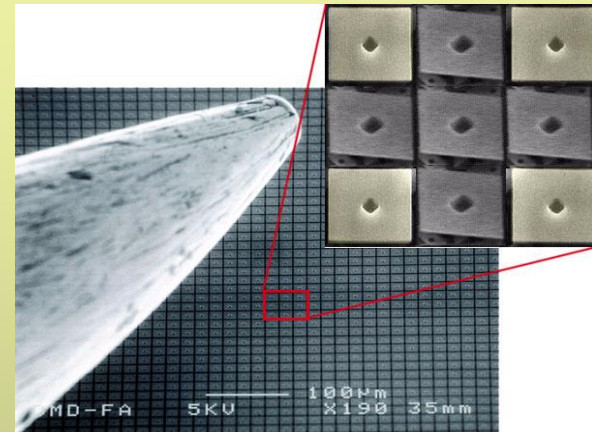

maskless array synthesizer
(e.g. Nimblegen)



CARP Gene database & bioinformatics tools for microarray selection



CarpBase: over 15.000 expressed
sequence tags (ESTs)

NCBI: over 10.000 uncurated sequences

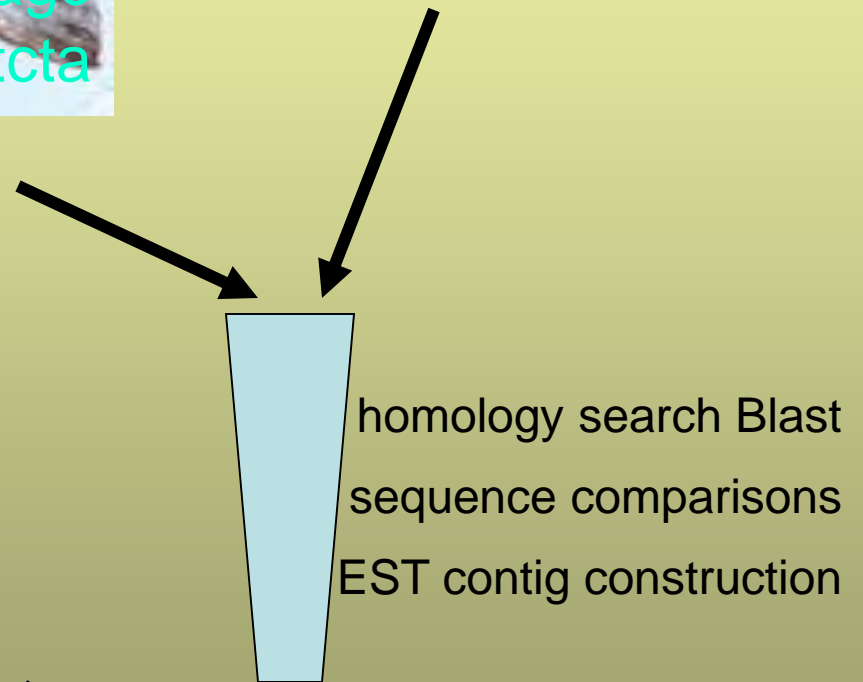

Probe Design

15.000 gene-specific
oligonucleotide sequences



DNA-microarray construction

15.000 cured ESTs,
functional groups,
gene families,
annotation

Ponty DNS-microarray formátum

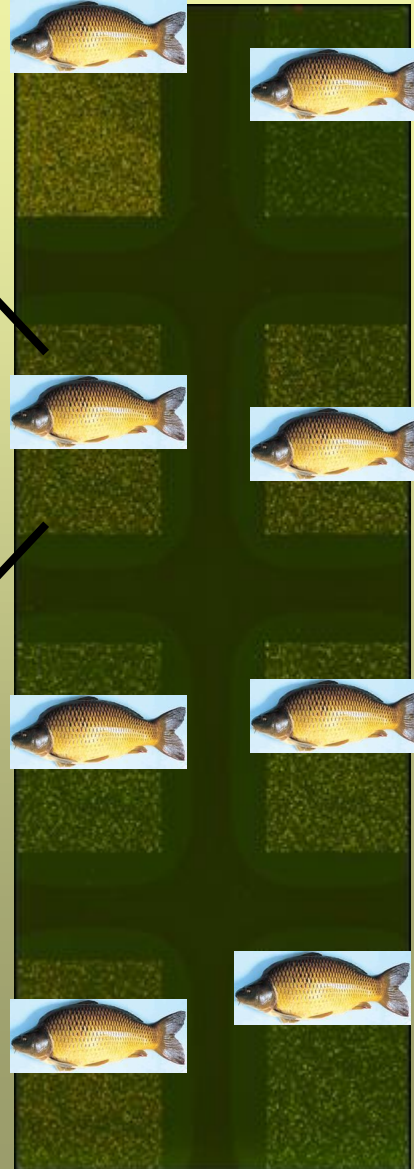
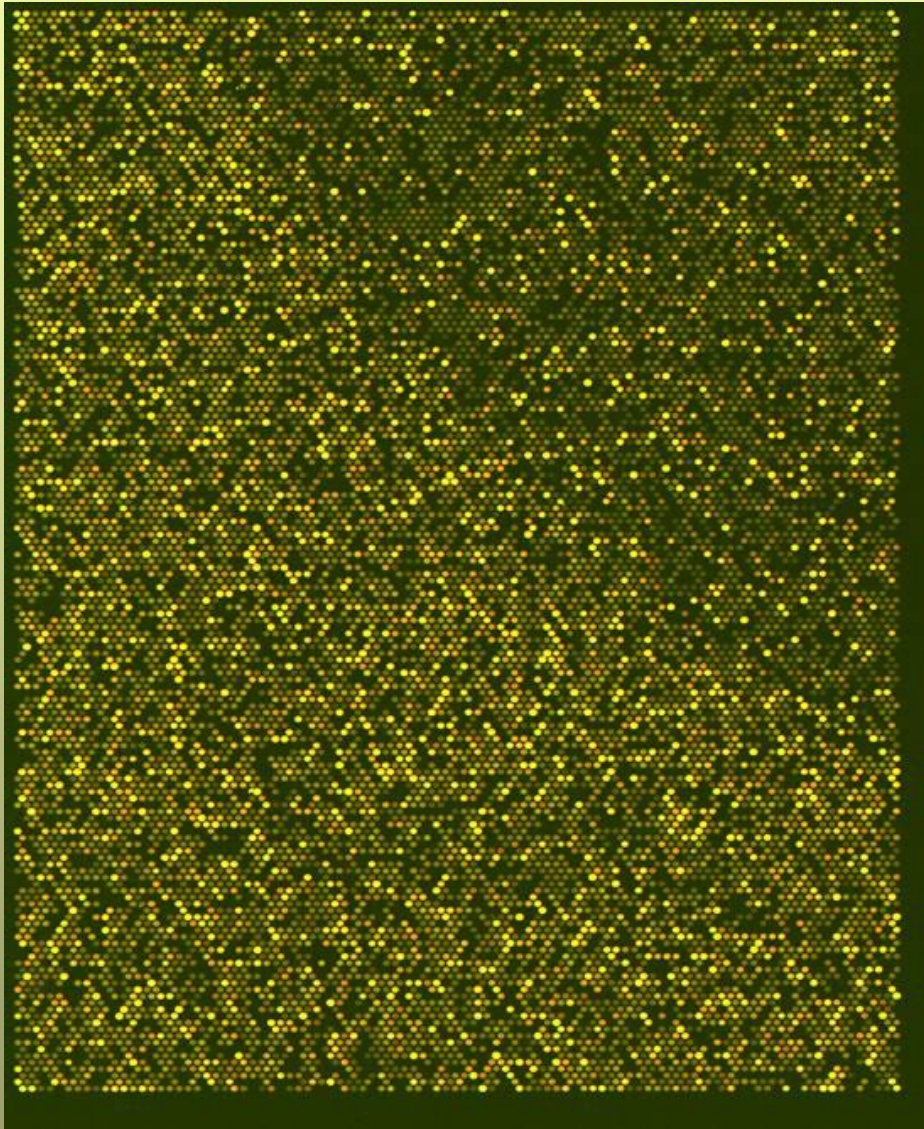

**Analysis of
8 carps in
1 microarray
experiment
15.000 gene
analysis
each**

Különböző stressznek kitett pontyok (vér, máj, kopolytú) génextpressziós vizsgálata

hipoxia stressz

Szelénium hiány

Zsúfoltsági teszt



Sample collection (gill, blood, liver)
RNA preservation
transportation
RNA preparation
cDNA conversion
(banking for future studies)
DNA-microarray
HTS-QRT-PCR

Egy csipkísérlet általános lépései

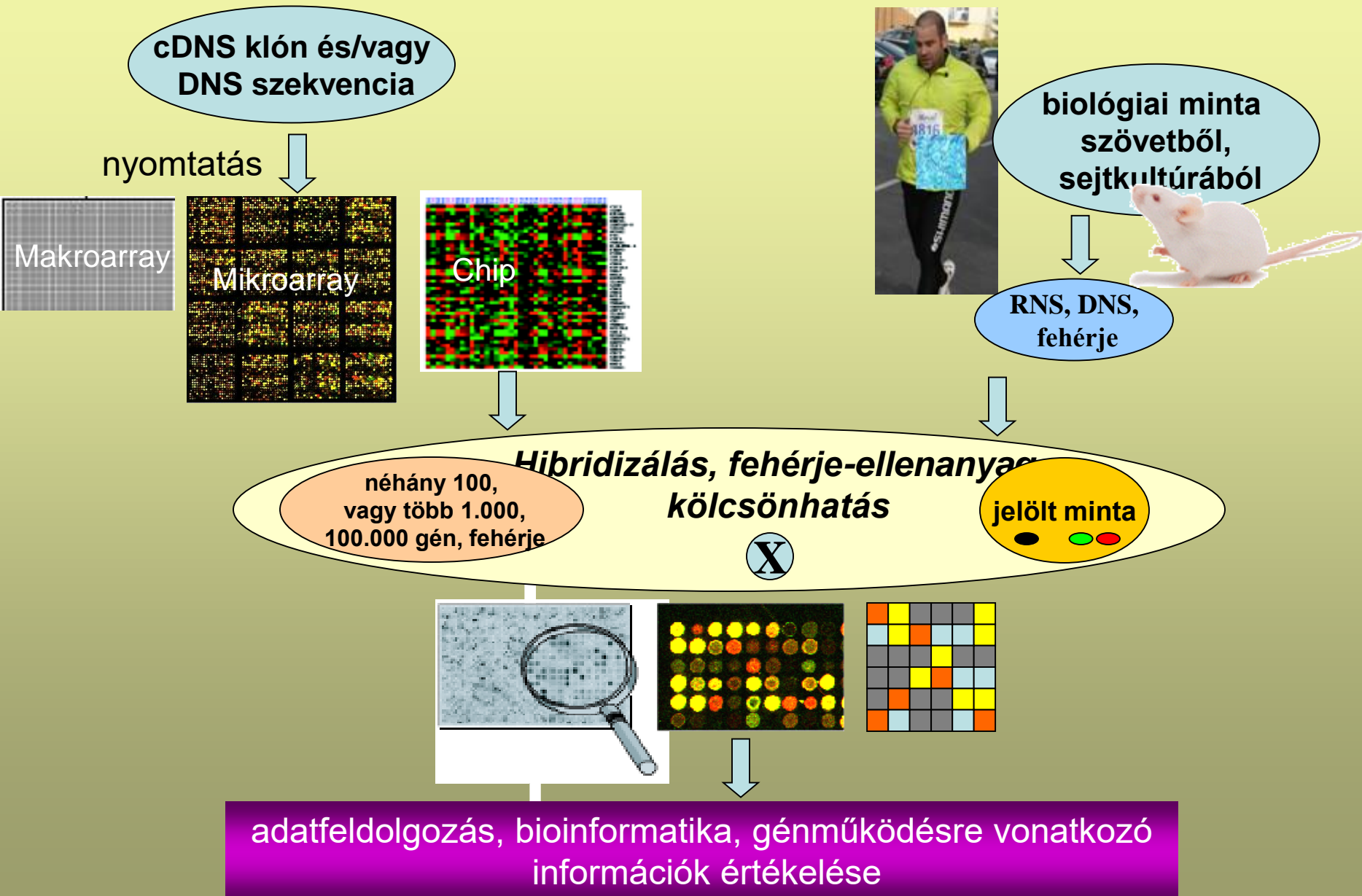

Microarray vs. SAGE vs. TaqMan vs. NGS

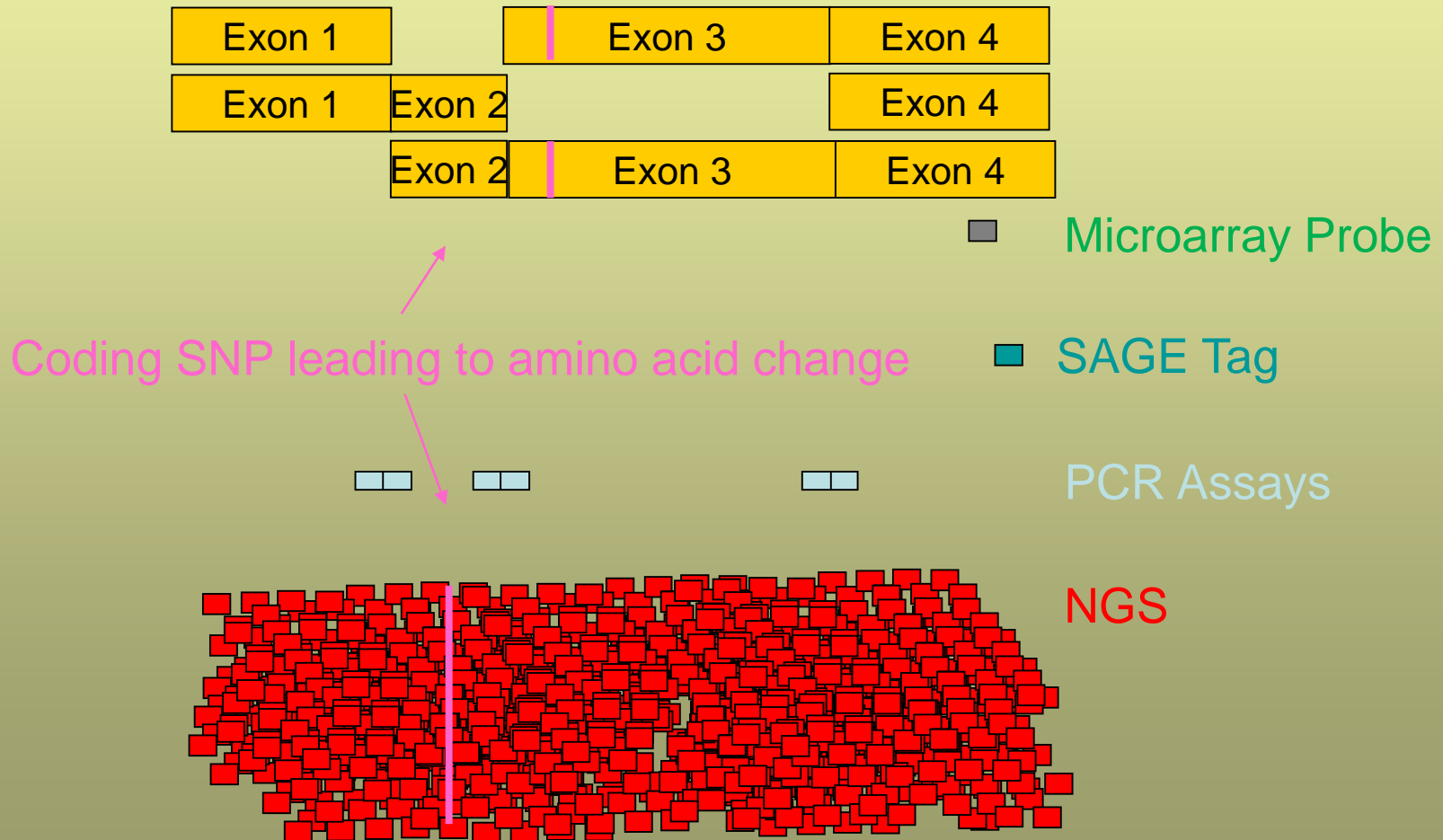

A táplálék kölcsönhatása a génekkel, génállománnyal

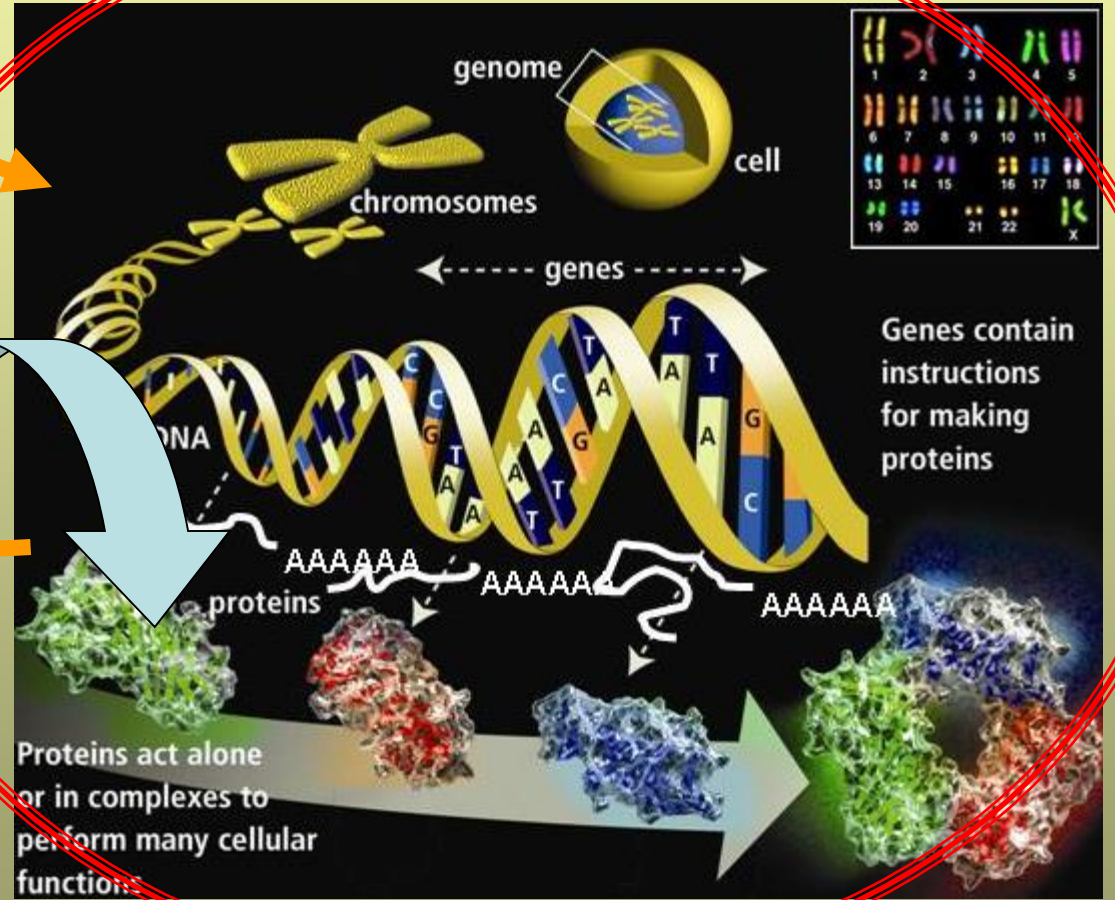

Rövidtávú és Hosszútávú hatások sejt szintű és Fiziológiás változások

Kitajka et al. (2002) PNAS 99, 2619;
Barcelo-Coblijn, G (2003) PNAS 100, 11321.
Kitajka (2004) PNAS 101, 10931
Puskás et al. (2003) PNAS 100, 1580-1585.
Puskás et al. (2004) Biochimie 86, 817.
Jayasooriya et al (2005) PNAS 102, 7133.
Puskas et al. (2006) Curr Pharm Biotechnol. 7, 525
Puskas LG, Kitajka K. (2006) Nutr Health. 18, 227
Ménesi D et al. (2009) Prostaglandins Leukot Essent Fatty Acids
DasUN, Puskas LG (2010) Lipids Health Disease

N-3 politelítetlen zsírsavakat tartalmazó diéta hatásának vizsgálata cDNS-chip technológiával

halolajjal
etetett

kontroll



RNS

cDNS

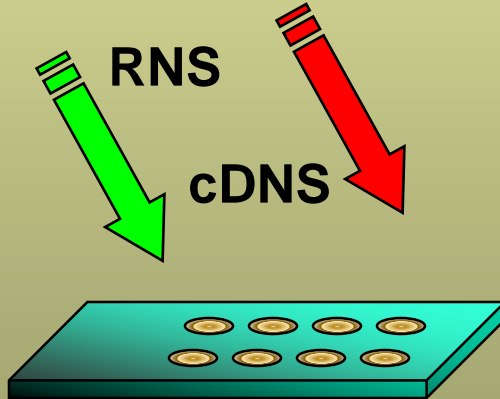

patkány cDNS-chip
3200 génspecifikus minta
6400 mintapont

Génexpressziós változások

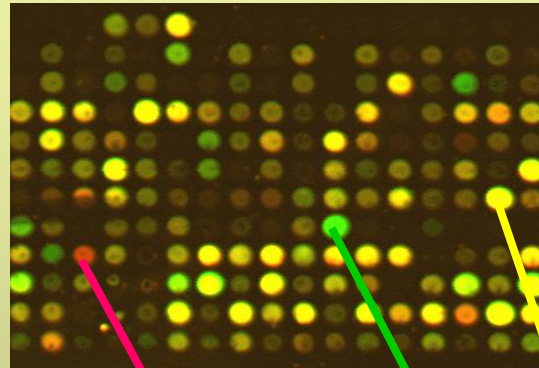

szinaptikus plaszticitás
citoszkeleton
jelátviteli folyamatok
energia metabolizmus
membrán asszociáció
ioncsatorna képzés
transzkripció faktorok

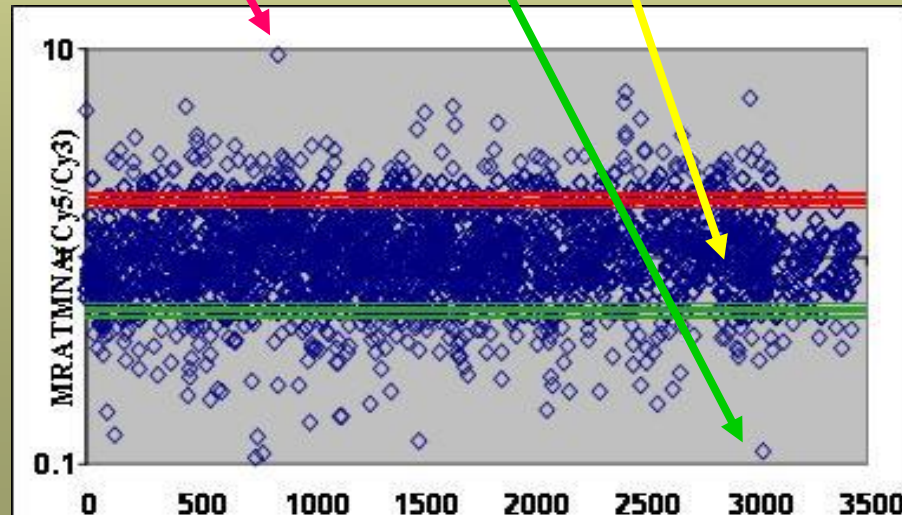

Pozitív hatás a mentális funkciókra, Tanulás, memória

Felfedezés (Discovery)

1. Target alapú szűrések

1a: új target azonosítása

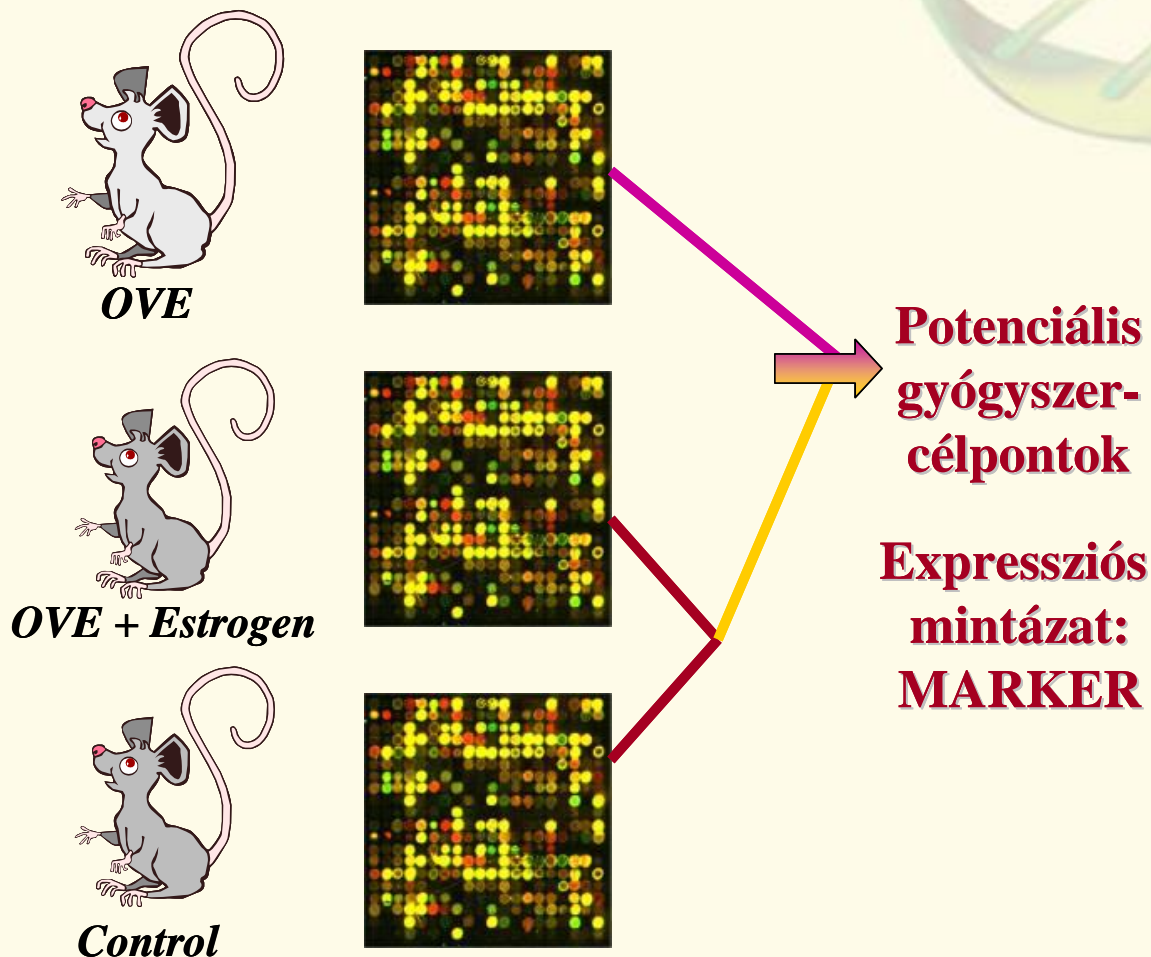

Génexpressziós változások Ac915-tel kezelt KO-egér májkarcinómában

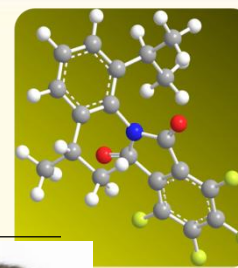

Tumorigenesis: DEN, 15 naponan egyszeri 50 ul-es kezelés, 4 hónap normál táp

Kezeletlen kontroll

Kezeletlen

Ac915 kezelés:

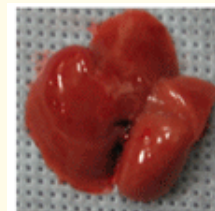
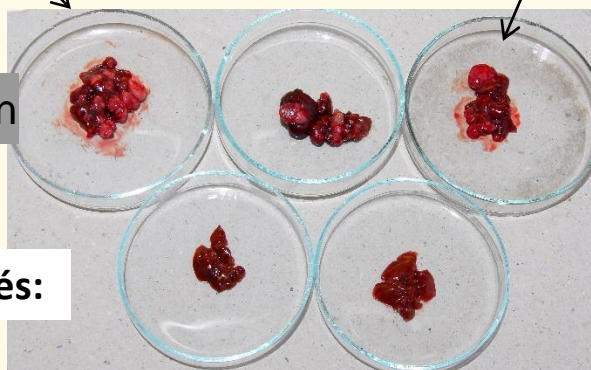

Tumor izolálás

Egészséges szövet izolálás

Egészséges szövet izolálás

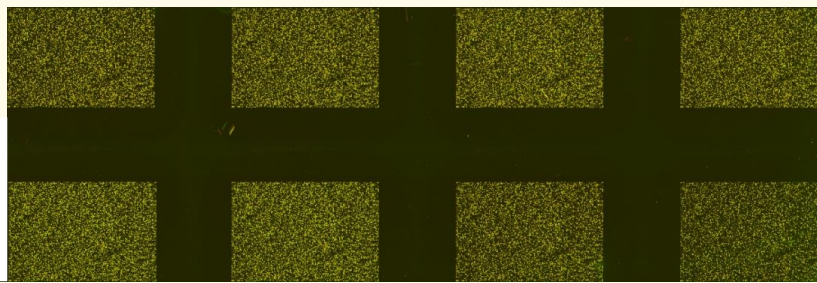

Funkcionális elemzés

Ac-915 tumor / induced tumor

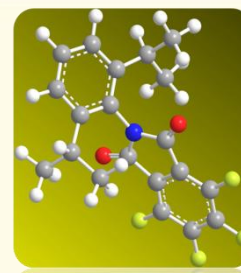

- DAVID bioinformatics
- WEB alapú rendszer
- Input: gén lista
- Funkcionális “csoportok” (GO terms, pathways, tissue expression pattern etc.)
- Géncsoportosítás azonos funkció szerint
- Szignifikancia analízis, p-value

Overexpresszált gének.

Ac-915 tumor / induced tumor

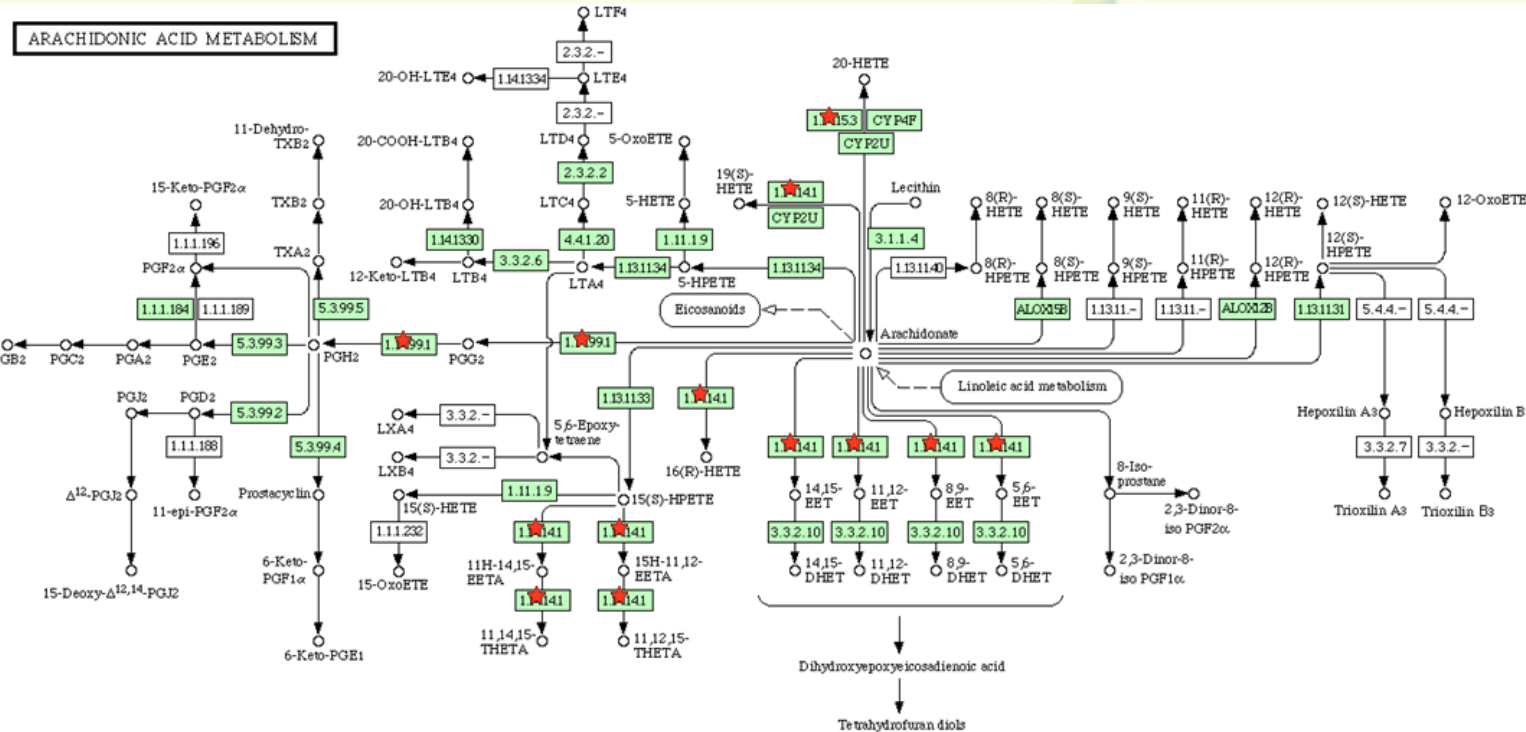
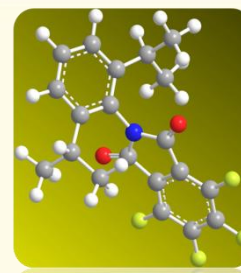

Cyp2c54
Cyp2j9
Cyp2e1
Cyp2c55
Cyp2c37
Ptgs1
Cyp4a12b

[cytochrome p450](#)
[cytochrome p450, family 2, subfamily j, polypeptide 9](#)
[cytochrome p450, family 2, subfamily e, polypeptide 1](#)
[cytochrome p450, family 2, subfamily c, polypeptide 55](#)
[cytochrome p450, family 2. subfamily c, polypeptide 37](#)
[prostaglandin-endoperoxide synthase 1](#)
[cdna sequence bc060945](#)

Represszált gének.

Ac-915 tumor / induced tumor

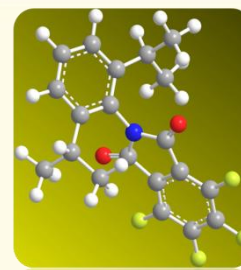

Term	Count	%	PValue	Genes
:0007010~cytoskeleton organization and biogenesis	28	7.31%	1.17E-05	Myh11, Arhgef11, Myo7a, Epb4.1l2, Dlg1, Arpc2, Tagln, Trpm7, Tubd1, Snap23, Rdx, Ndel1, Birc5, Actg2, Krt1, Ppp4c, Pfn2, Tbce, Wasl, Lcp1, Tubb4, Cenpj, Vill, Tuba1a, Fmn1, Capn3, Dnaic1, Rhoq,
:0015630~microtubule cytoskeleton	16	4.18%	0.00664	Cetn3, Dynlt3, Tubb4 , Cenpj, Nek2, Akap9 , Cenpf, Tubd1 , Tuba1a , Cdc2a, Ndel1, Birc5, Brca1, Npm1, Dnaic1, Ppp4c,
:0007049~cell cycle	29	7.57%	9.93E-04	Gadd45a , Rras , Dlg1, Ncapd2, Cdca3, Anxa1, Cdc2a, Birc5, Brca1, Psm13, Npm1, Tgfa, Rbm7, Jun , Pcnp, Btg3, Cetn3, Tsc2, Mns1, Ccna2 , Maff, Nek2, Cdkn2c, Cenpf, Ddit3 (DNA-damage inducible transcript 3) , Txnip, Ccnb1 , Ube2c, Pttg1,
:0000278~mitotic cell cycle	14	3.66%	0.00237	Btg3 , Cetn3, Dlg1, Ccna2, Nek2, Ncapd2, Cenpf, Cdca3, Cdc2a, Birc5, Ccnb1, Ube2c, Tgfa, Pttg1,
:0051301~cell division	11	2.87%	0.02743	Arhgef11, Cetn3 , Birc5 , Ccnb1, Ccna2, Nek2, Ube2c, Ncapd2, Cdca3 (cell division cycle associated 3) , Pttg1, Cdc2a ,
:0000902~cell morphogenesis	21	5.48%	0.00541	Arhgef11, Ing2, Tsc2, Wasl, Tubb4, Myo7a, Egfr , Epb4.1l2, Dlg1, Igfbp4 , Ctnna1, Rdx, Ndel1, Alcam, Brms1l, Igfbp7 , Rhoq, Cdc42se1, Tbce, Btg1, Pak2,
:0031410~cytoplasmic vesicle	16	4.18%	0.00568	Pla2g4a, Snapin , Myo7a, Egfr , Snap23, Tff3, Pdpk1, Rab7 , Sec23ip , Spg21, Tlr1, Nostrin, Sec24b, Pip5k3, Ica1, Sec23a ,
:0007088~regulation of mitosis	5	1.31%	0.01555	Birc5 , Dlg1 , Tgfa , Cenpf , Cdc2a ,
:0048193~Golgi vesicle transport	6	1.57%	0.03495	Rab6 , Stx6 (syntaxin 6) , Sec24b , Lman1, Sec23a, Snap23,
:0015630~microtubule cytoskeleton	16	4.18%	0.00664	Cetn3, Dynlt3, Tubb4, Cenpj, Nek2, Akap9, Cenpf, Tubd1, Tuba1a, Cdc2a, Ndel1, Birc5, Brca1 , Npm1, Dnaic1, Ppp4c,

The **ArrayExpress Archive** is a database of functional genomics experiments including gene expression where you can query and download data collected to **MIAME** and **MINSEQE** standards. **Gene Expression Atlas** contains a subset of curated and re-annotated Archive data which can be queried for individual gene expression under different biological conditions across experiments.

Experiments Archive

33537 experiments, 969491 assays



Experiment, citation, sample and factor annotations

[Browse experiments](#) | [platform designs](#) | [protocols](#) | [files](#)

Query

Gene Expression Atlas

3558 experiments, 99484 assays, 20806 conditions

Genes

up/down in

Conditions

Any species

Query

[Gene Expression Atlas Home](#)

Experiment, citation, sample and factor annotations [clear]

ArrayExpress data only

[Advanced query syntax](#)

[Submitter/reviewer login](#)

[ArrayExpress Browser Help](#)

Filter on [reset]

Oryza sativa

All arrays

All assays by molecule by All technologies

Display options [reset]

25 experiments per page

Detailed view

Query

Accession	Title	Assays	Species	Date	Processed	Raw	Atlas
E-GEOD-11014	A diverse set of microRNAs and microRNA-like small RNAs in developing rice grains	6	Oryza sativa	2008-08-20			-
E-GEOD-22564	A global analysis of QTLs for expression variations in rice shoot at early seedling stage	226	Oryza sativa Indica Group	2011-06-24			-
E-GEOD-28308	A single functional blast resistance gene Pi54 activates complex defense mechanism in Rice	8	Oryza sativa Japonica Gro	2011-12-08			-
E-GEOD-13161	A transcriptome atlas of rice cell types uncovers cellular, functional and developmental hierarchies	168	Oryza sativa	2010-05-19			-
E-GEOD-14729	A transcriptomic analysis of super-hybrid rice LYP9 and its parental lines	96	Oryza sativa	2009-04-22			-
E-GEOD-33409	Abscission layer (AL) at the base of flower in rice using laser micro-dissection: NIL(qSH1) AL vs. Nipponbare AL, NIL(qSH1) AL vs.	11	Oryza sativa	2012-03-31			-
E-GEOD-21772	affy_meloidogyne_rice2-Oryza sativa genes expressed in the early compatible interaction with root-knot nematode	6	Oryza sativa	2011-09-24			-
E-GEOD-34192	affy_riz_2011_7-: Transcriptomic analysis of rice leaves challenged with virulent and avirulent Xoo strains	18	Oryza sativa	2012-10-15			-
E-GEOD-19844	affy_xoo_rice-Transcriptomics-based identification of Xoo strain BAI3 Talc targets in rice	9	Oryza sativa	2010-12-01			-
E-GEOD-40964	Agilent 44K Rice Oligo DNA Microarray RAP-DB (G2519F#15241); genome-wide transcriptional analysis of Aluminum-responsive g	16	Oryza sativa	2012-09-19			-
E-GEOD-14462	An Expression Alteration of Small RNA Profiling in Autotriploids Derived from Rice Twin-Seedlings	2	Oryza sativa	2009-07-14			-
E-GEOD-27726	Analysis of anther transcriptomes to identify genes contributing to meiosis and male gametophyte development in rice	12	Oryza sativa Indica Group	2011-06-10			-
E-GEOD-16796	Analysis of PHOTOPERIOD SENSITIVITY5 Sheds Light on the Role of Phytochromes in Photoperiodic Flowering in Rice	4	Oryza sativa	2010-05-16			-
E-GEOD-5986	Analysis of Rice microRNAs Expression under Drought Stress	24	Oryza sativa	2010-06-11			-
E-GEOD-8670	Analysis of the Interaction Transcriptome During Biotrophic Invasion of Rice by the Blast Fungus, Magnaporthe oryzae	24	Magnaporthe oryzae, Oryz	2009-04-08			-
E-GEOD-7567	BTH-responsive rice genes	8	Oryza sativa	2010-06-05			-
E-GEOD-17169	bulked RILs with high and low grain number per panicle derived from 2 cultivars at panicle primordia stage	4	Oryza sativa Indica Group	2009-12-31			-
E-GEOD-13152	Characterization of unique small RNA populations from rice grain	4	Oryza sativa	2008-11-24			-
E-GEOD-35502	Characterizing the role of rice NRAMP5 in Manganese, Iron and Cadmium Transport	20	Oryza sativa Japonica Gro	2012-02-03			-
E-GEOD-8767	Chilling stress transcriptional regulatory networks of japonica rice	44	Oryza sativa	2009-12-30			-

Adatbáziskutatás, adatbányászás

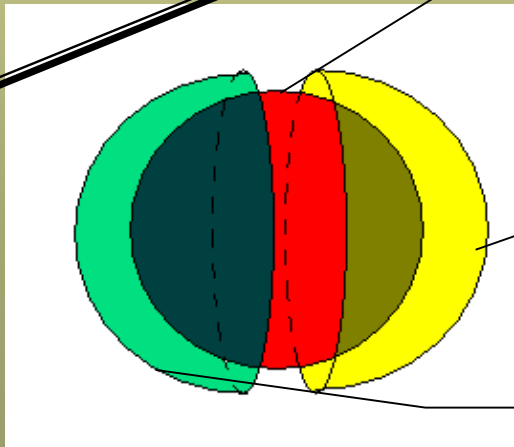
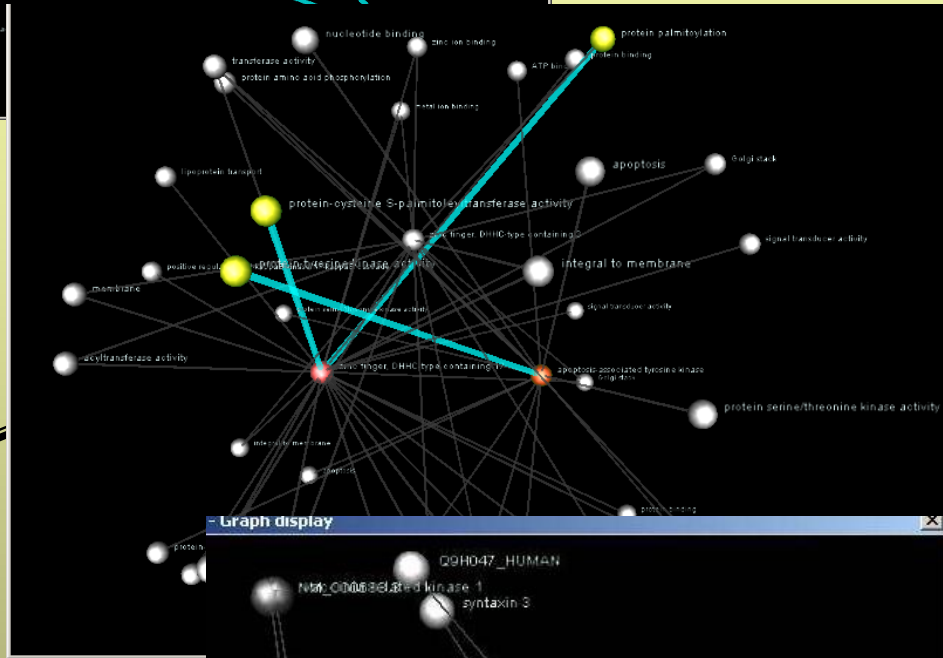
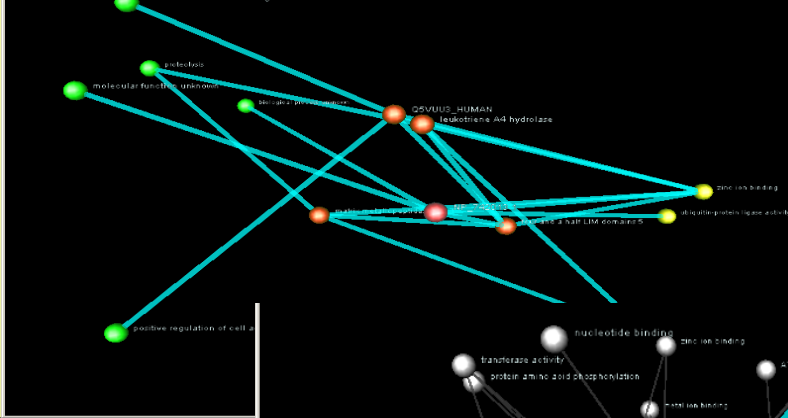
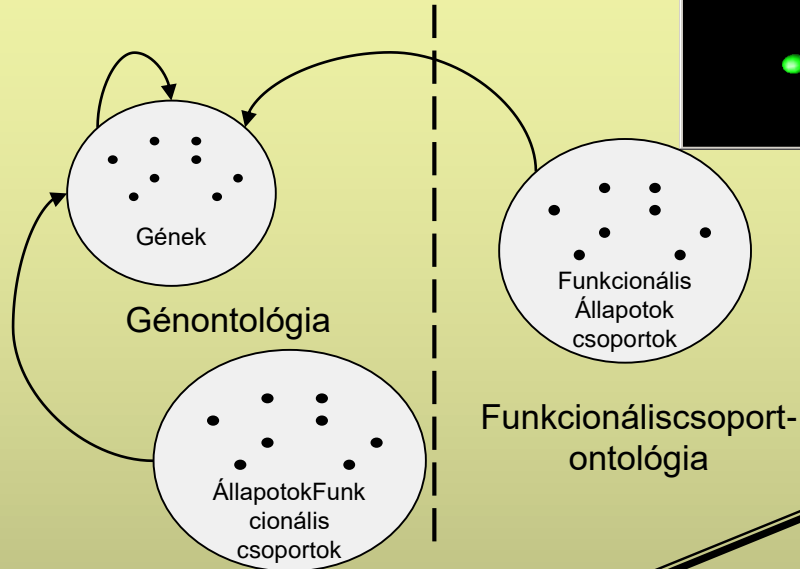

Ontológiák

Állapotok

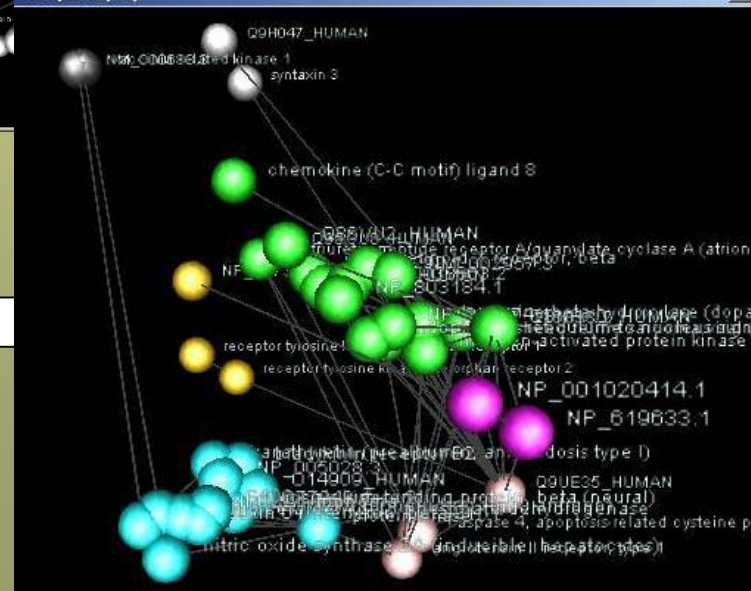

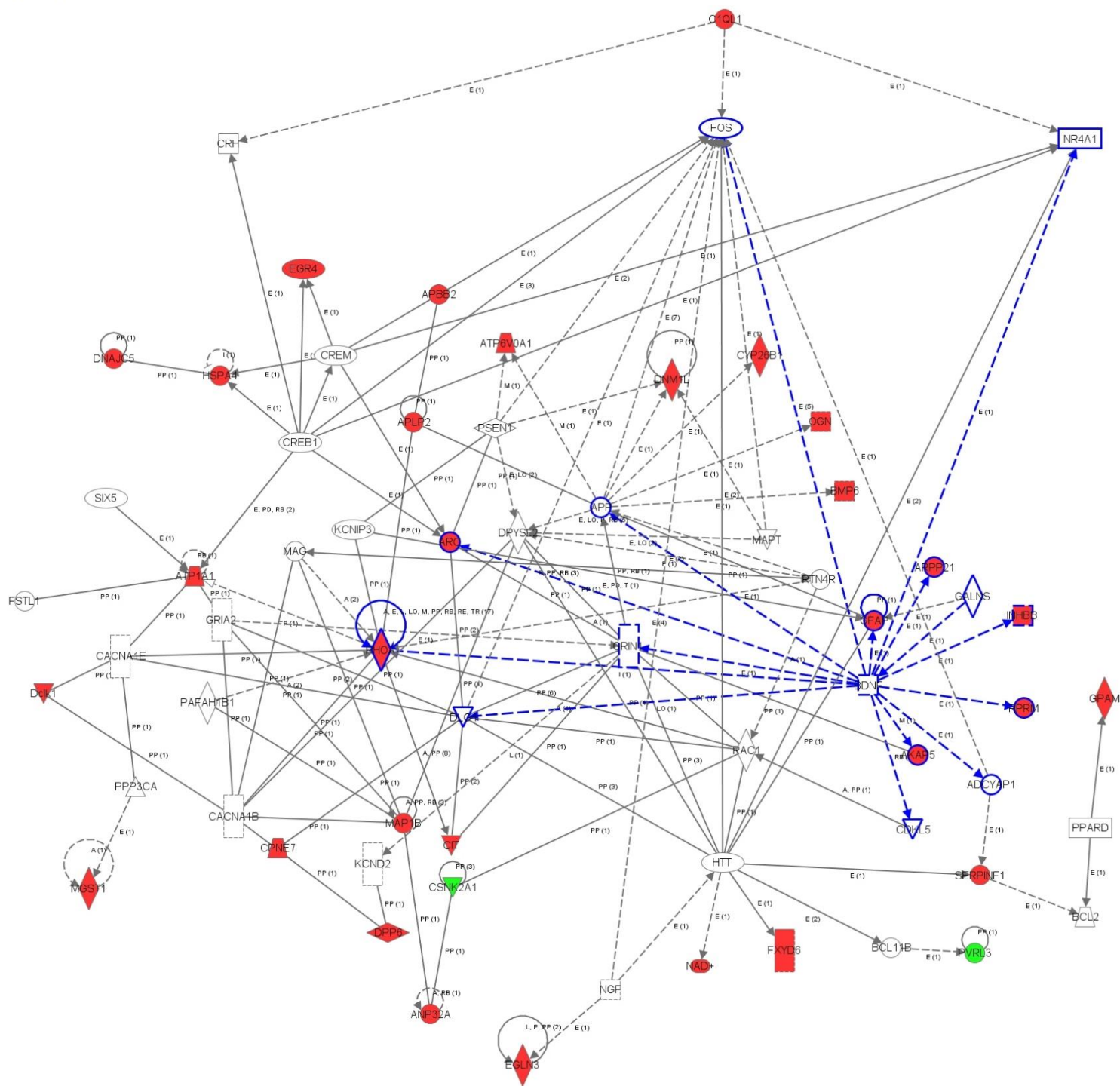

Application of global genomic screening technologies in cancer genomics:

Tumor sample

Normal sample



RNA

cDNA

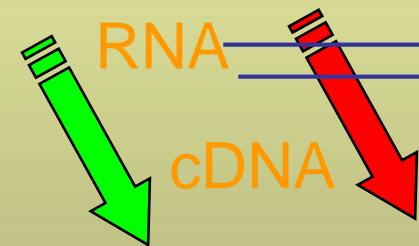

DNA-microarray containing 40,000 different human gene probes

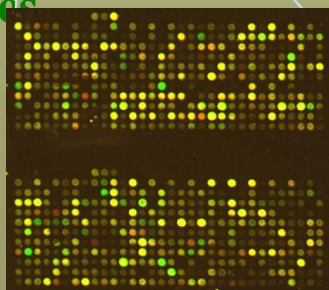

Illumina Next generation sequencing

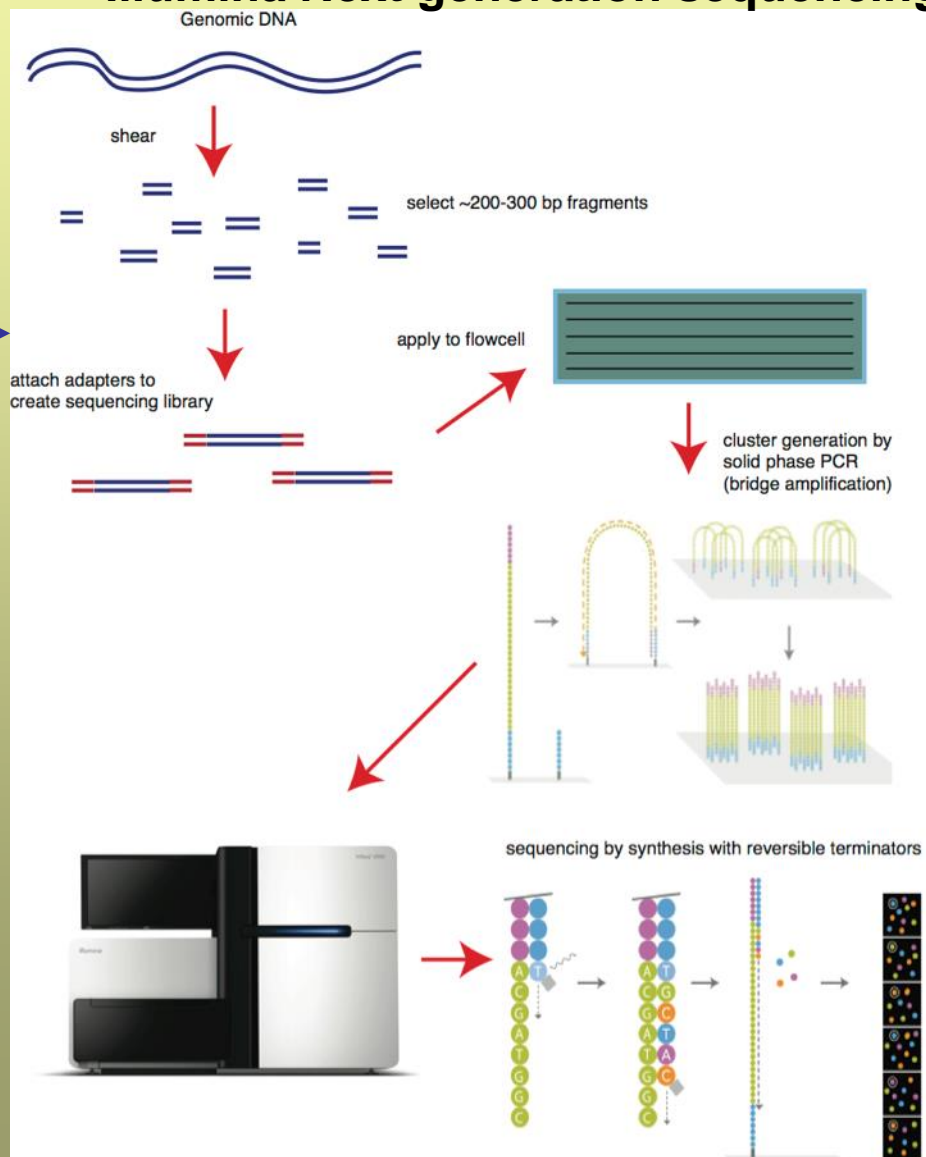

Complex regulatory networks, disregulation of signalling pathways result in gene expression differences (8000!)

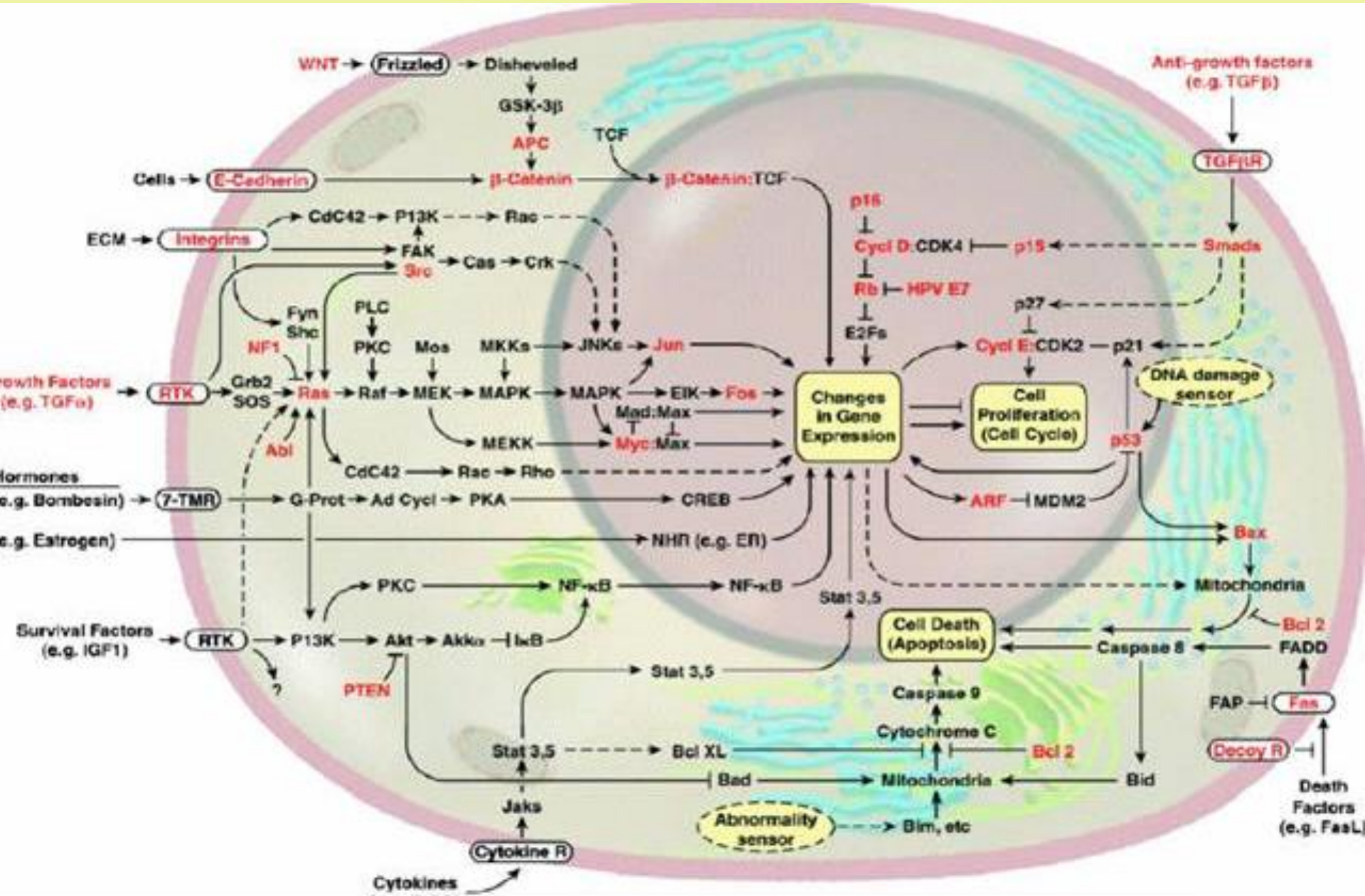

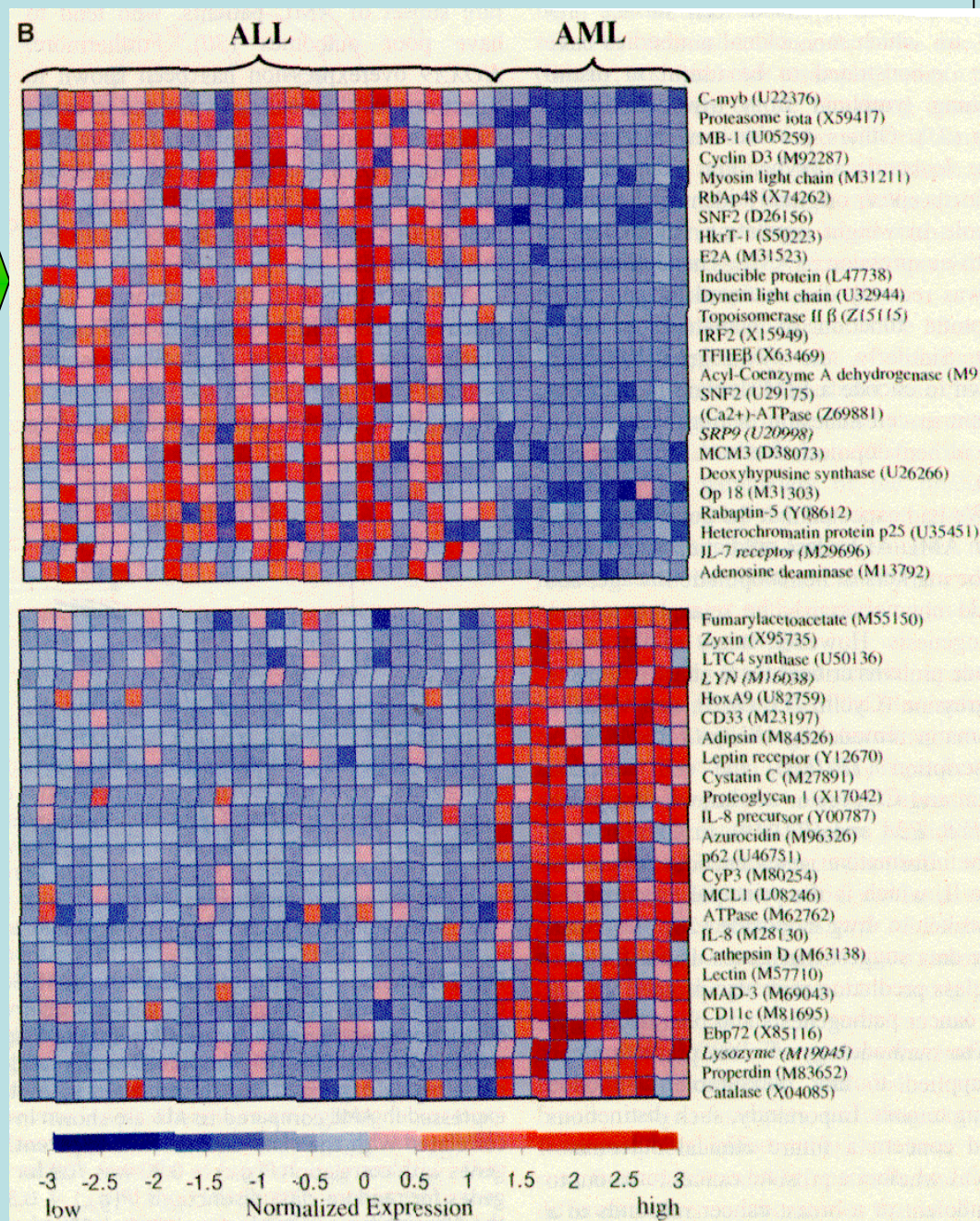
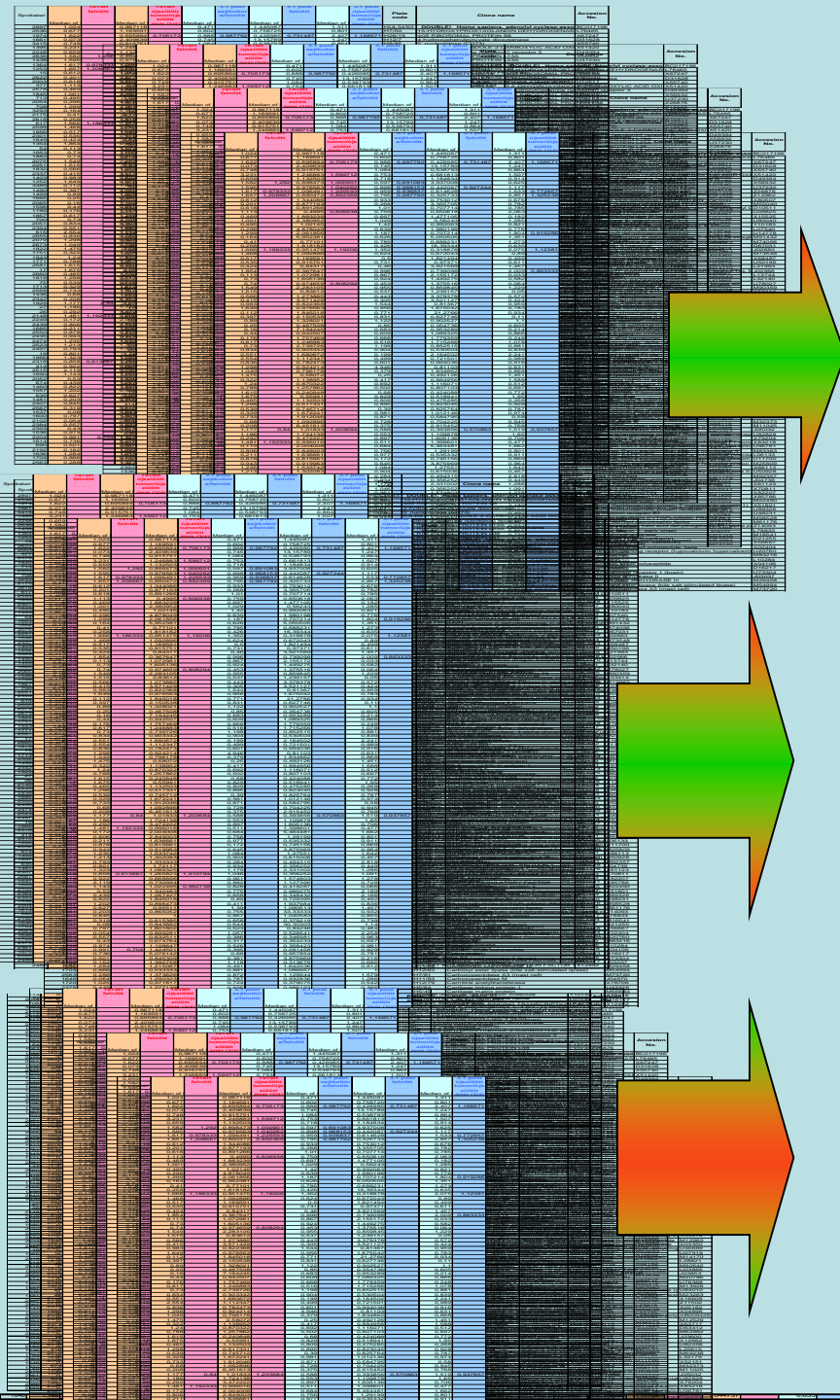

Különböző pajzsmirigy eredetű betegségek hierarhikus klaszteranalítise

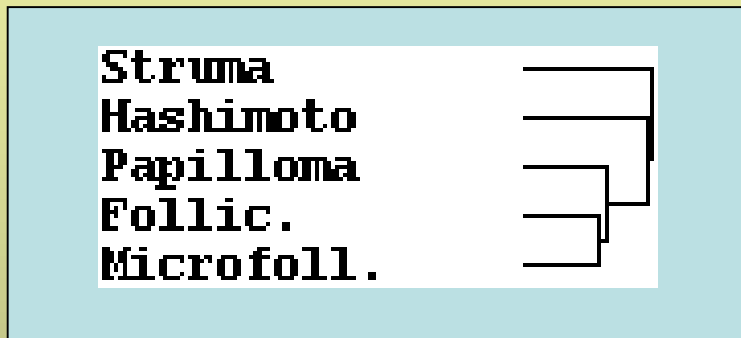

Hierarchical cluster analysis with Omniviz

Betegség-specifikus klaszterek meghatározása

Legközelebbi kapcsolat: microfollicular & follicular carc., papilloma ehhez az alcsoporthoz hasonlít.

Struma and Hashimoto különböznek egymástól és más betegség csoportoktól.

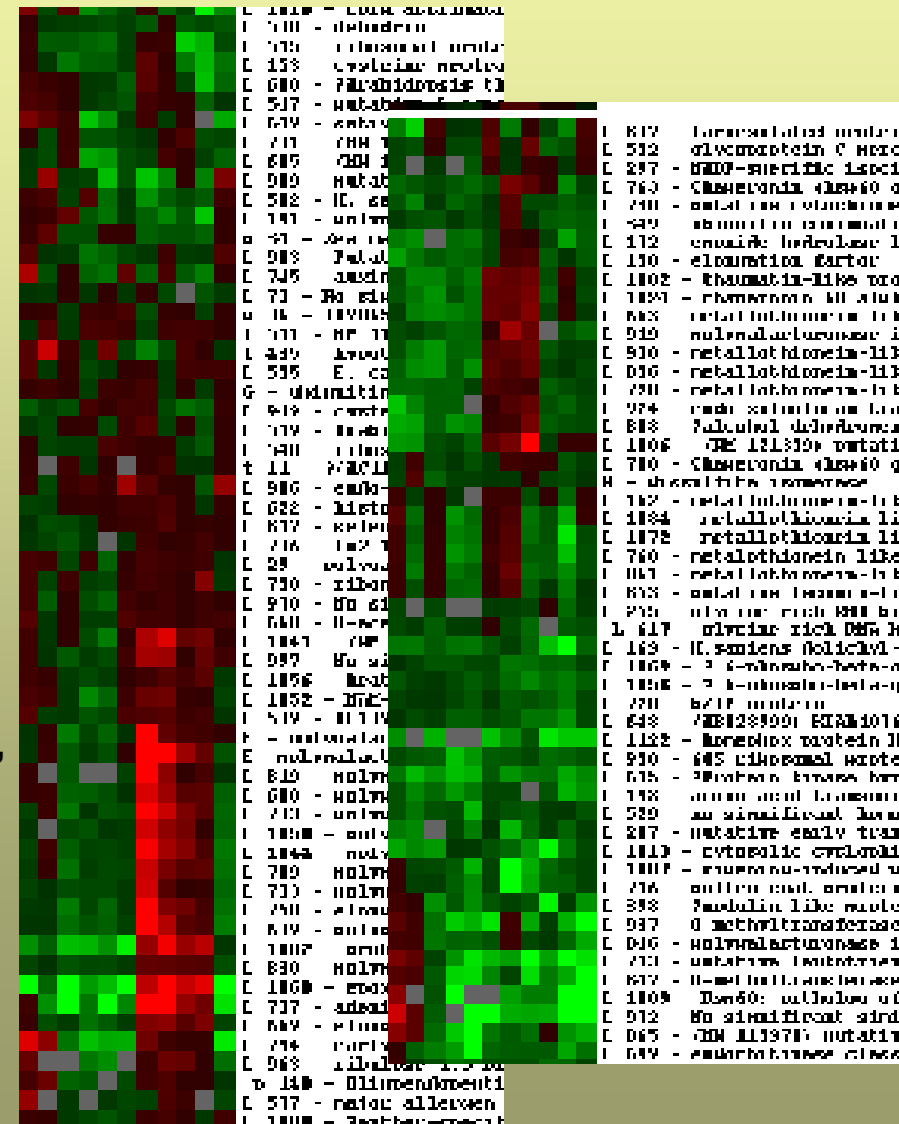

Betegségspecifikus génmarkerek azonosítása

Struma

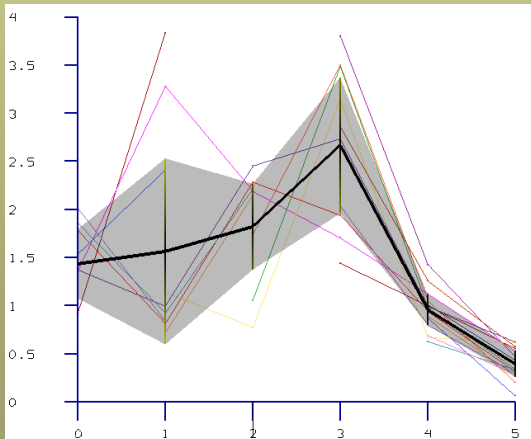
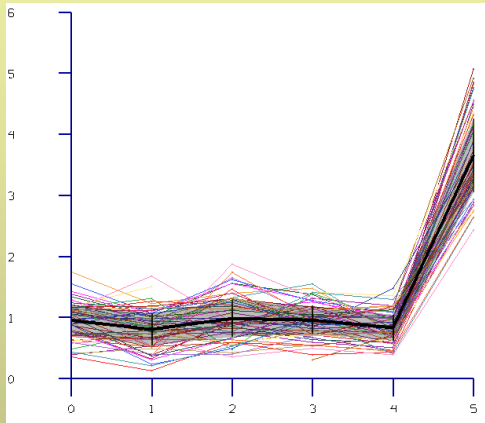

Microfollicular + Struma

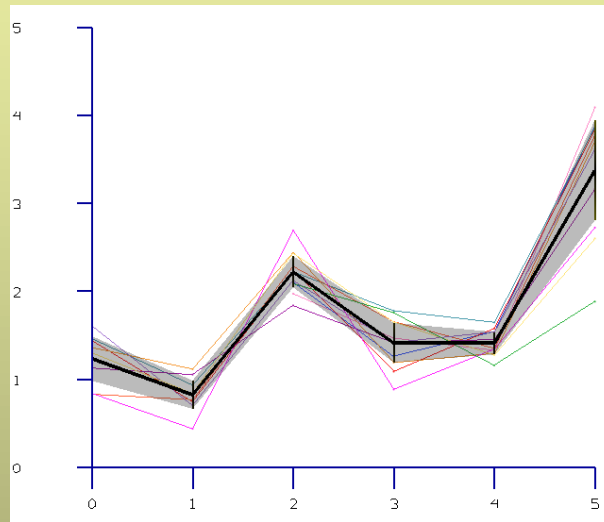

Hashimoto

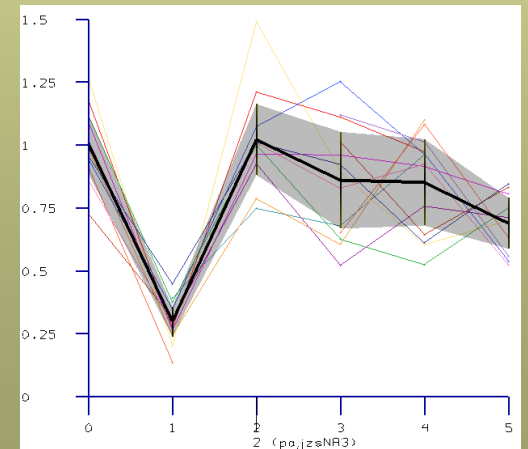
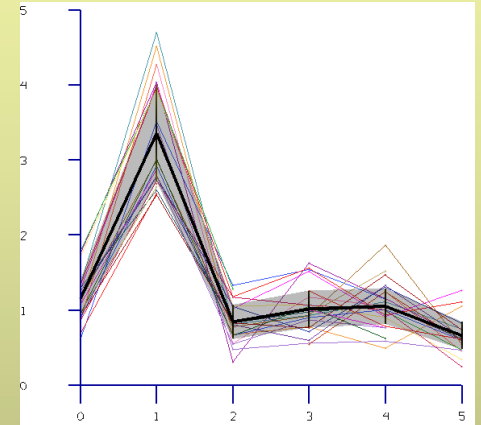

Körte érésével kapcsolatos gének azonosítása

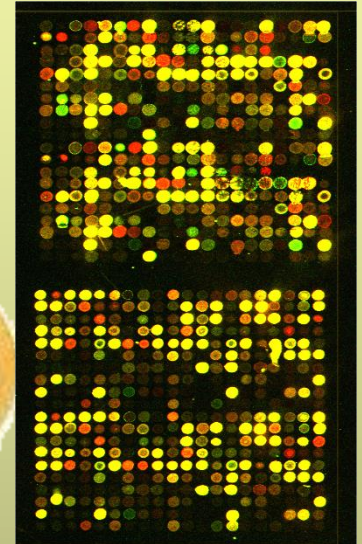
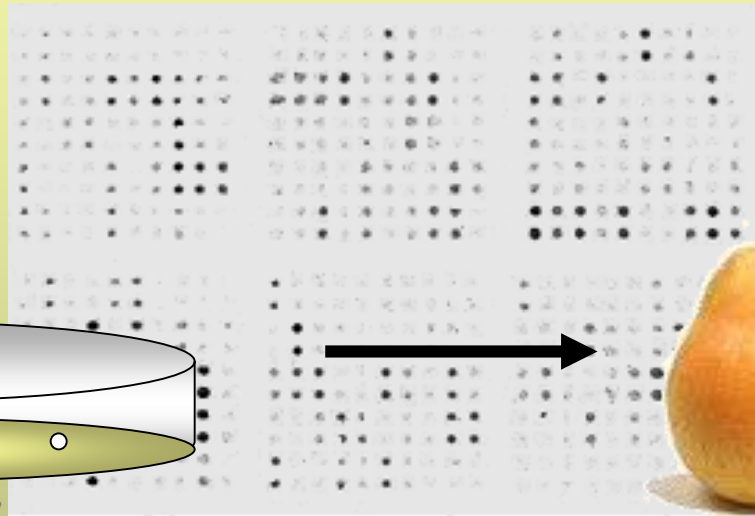
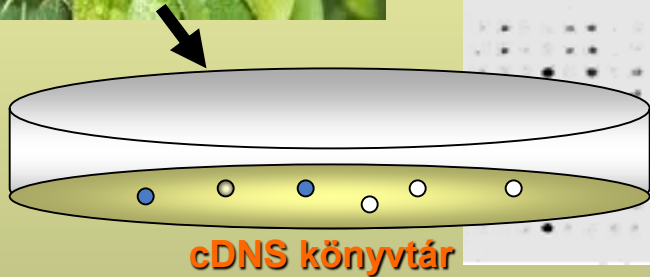

↓ ↓ ↓ ↓ ↓ ↓ ↓ ↓ ↓ ↓ ↓ ↓
A C 3 6 9 12 15 18 21 24 FR

A: növekvő kis termés

C: nem növekvő, éretlen
termés

FR: összeaszott, éretlen termés

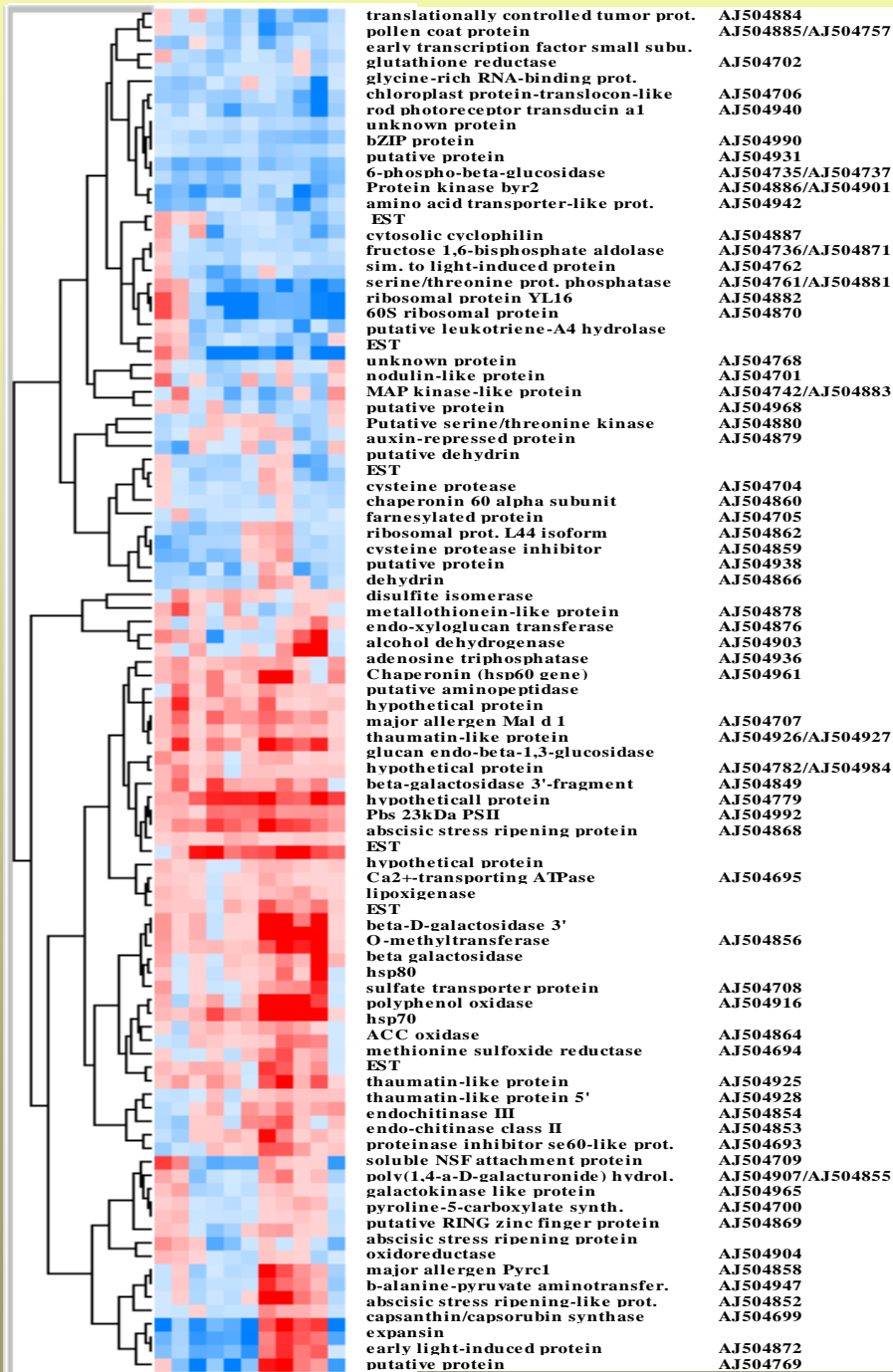

Nem érés specifikus

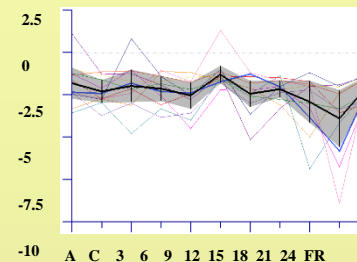

Gyümölcs növekedésre jellemző gének

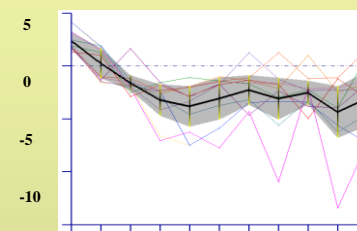

Gyümölcs növekedésre és érésre jellemző gének

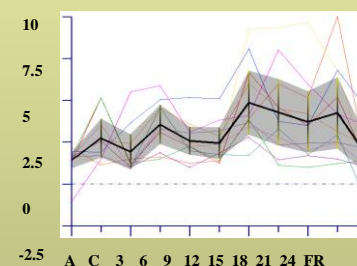

Gyümölcs érésre jellemző gének

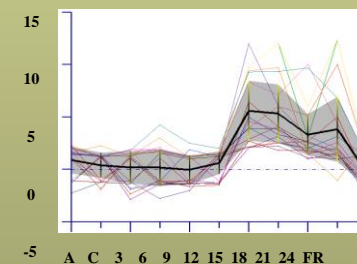

Gyümölcs érésre jellemző gének

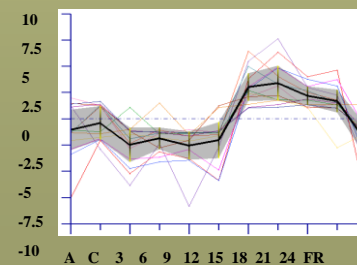

Flow of genetic information

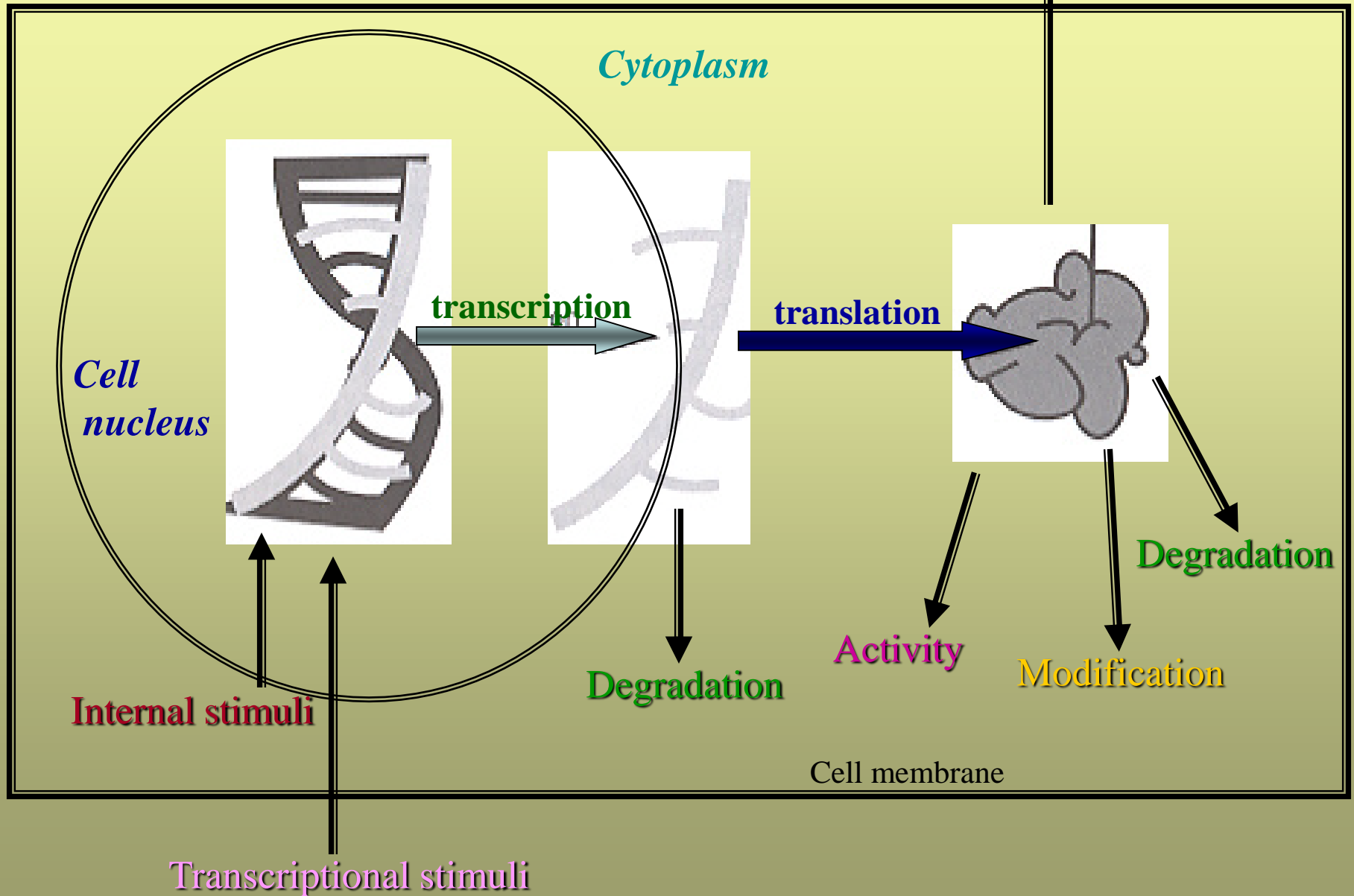

Minták heterogenitása, heterogén minták genomikai elemzése

1. Tumorasszociált miofibroblasztok célpontjai?

Term	Count	%	PValue	Genes
hsa05210:Colorectal cancer	10	1.5244	0.00829	TCF7,PIK3CB,MSH2,JUN,PIK3CD,LEF1,BIRC5,AKT3,DVL1,TGFB2
hsa05215:Prostate cancer	16	0.9715	0.02993	FGFR1,AR,MAP2K1,NFKBIA,FOXO1,RAF1,LEF1,NFKB1,TCF7L2,TCF7L1,EP300,GS
h_cd40Pathway:CD40L Signaling Pathway	5	0.4378	0.04075	IKBKG,NFKB1,CD40,TNFAIP3,IKKB
h_ceramidePathway:Ceramide Signaling Pathway	6	0.5254	0.0474	TNFRSF1A,BAX,MAPK3,SMPD1,NFKB1,FADD
h_compPathway:Complement Pathway	8	0.4857	0.00433	C7,MASP1,C3,CFB,C4B,C1R,C1S,CFD
h_nfkbPathway:NF-kB Signaling Pathway	7	0.613	0.01591	TNFRSF1A,IL1R1,IKBKG,NFKB1,FADD,TNFAIP3,IKKB
hsa04340:Hedgehog signaling pathway	15	0.9107	1.00E-03	BMP4,BMP2,STK36,CSNK1A1L,GAS1,GLI2,GLI3,PRKX,GLI1,WNT2,SMO,GSK3B,C
hsa04960:Aldosterone-regulated sodium reabsorption	6	0.9146	0.02751	PDPK1,ATP1B3,PIK3CB,PIK3CD,IGF1,ATP1A1

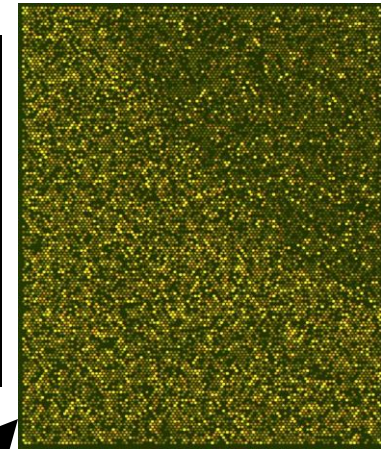

DNA-microarray

QRT-PCR

RNA

RNA

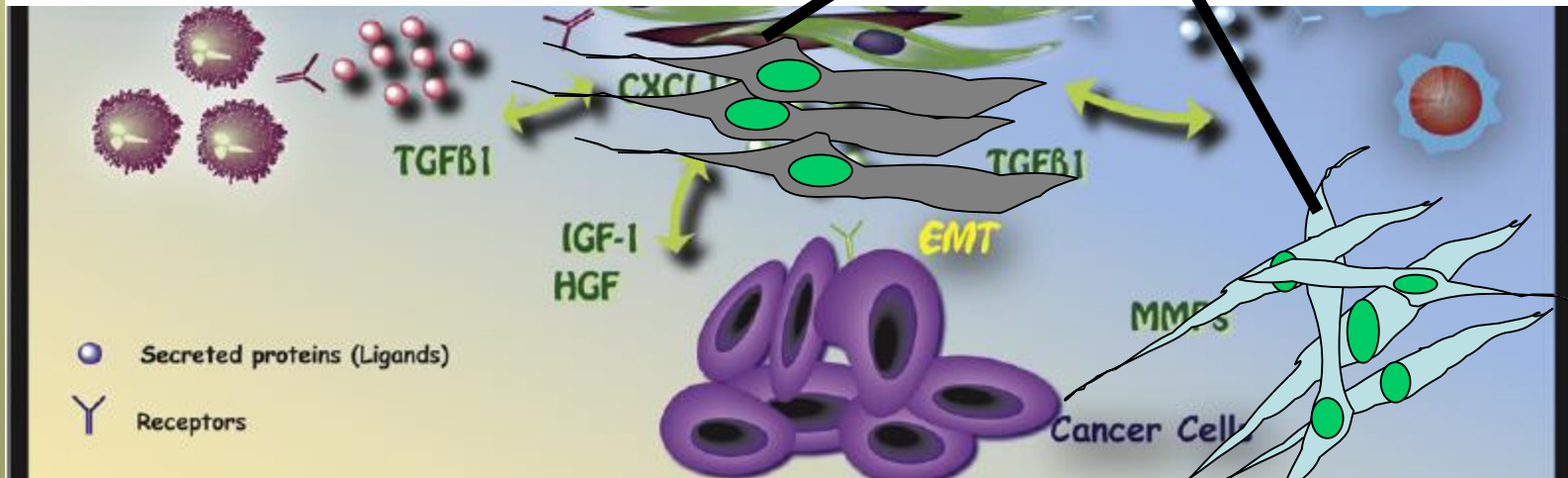

Péter Hegyi (Med. Univ. Szeged, 1st Intest.)

Imre Boros (BRC HAS, Univ Szeged)

Ágnes Zvara, Nóra Faragó (BRC HAS)

Tumorössejtek szerepe

CANCER GENOMICS & PROTEOMICS 6: 19-30 (2009)

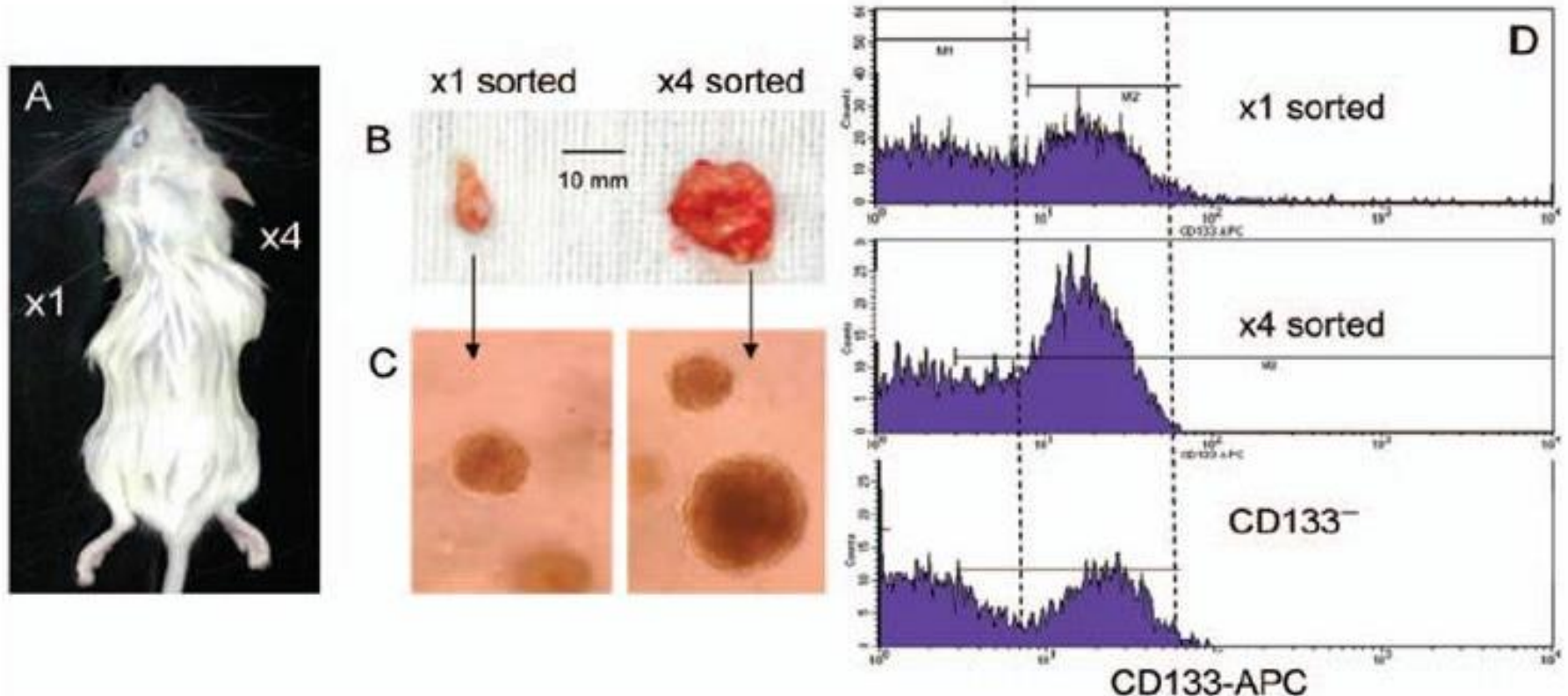
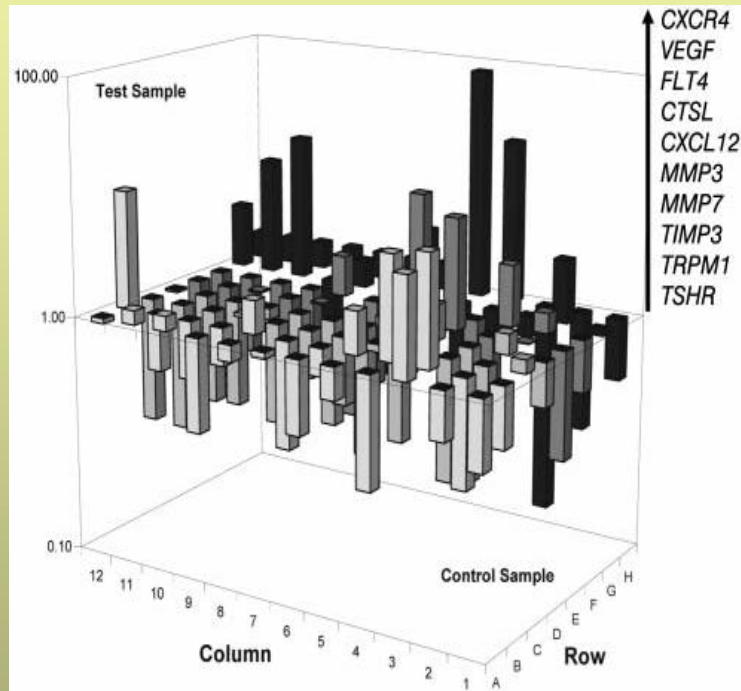

Figure 3. Increased in vivo tumorigenicity of repeatedly MACS-CD133⁺-sorted HCT116 cells. To minimize possible host differences, the same number (1.5×10^3) of one- and four-times sorted cells was injected into opposite flanks of NOD/SCID mice. Six out of six mice uniformly developed relatively small tumors after injection of one-time immunomagnetically sorted cells (A; left injection site, x1 CD133⁺), whereas repeatedly sorted cells induced significantly larger tumors in six of six out mice (A; right injection site; x4 CD133⁺). Removed tumors initiated by transplantation of repeatedly sorted CD133⁺ cells also displayed significantly higher levels of vascularization (B). Dissociated mouse tumor xenografts induced by repeatedly sorted CD133^{high} cells also possessed a higher ability to form floating spheres (C) and contained many more cells with high levels of CD133 (D).

Tumorössejtek géneexpressziós vizsgálata (QRT-PCR array)



Metasztázisban szereplő gének

CD133+

CD133-

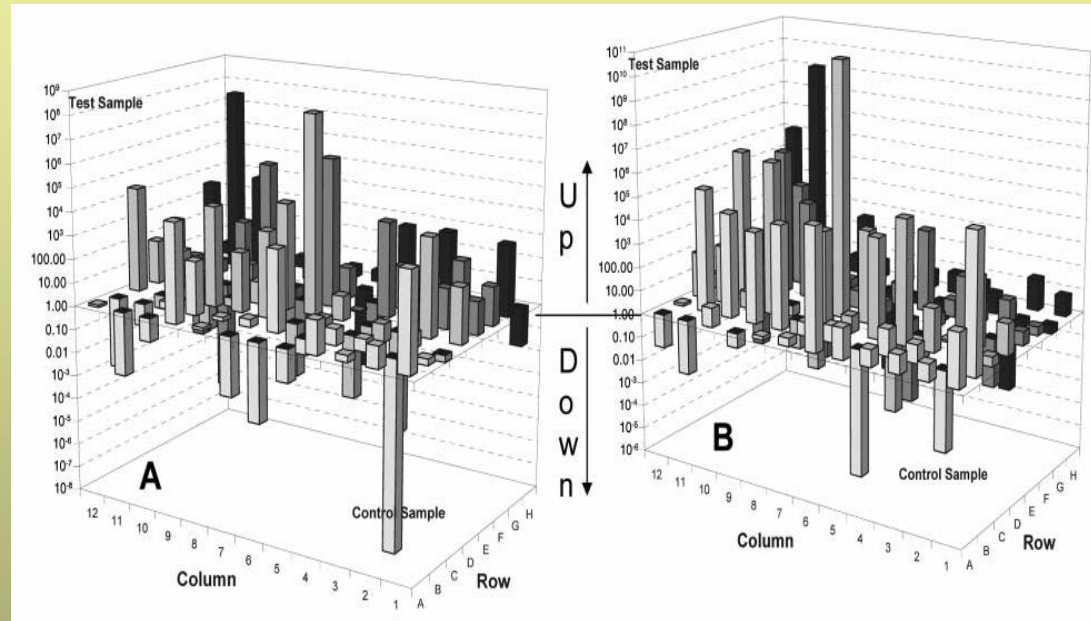

Össejt marker gének (ABCG2, NOTCH1/2, WNT1, FGF3,...)

Az agy sejtjeinek heterogenitása

rengeteg különböző sejtípus
nagyfokú heterogenitás
megértés, adatfeldolgozás
értelem, memória
neuronális hálózatok
patológias állapotokban
különböző sejtípusok szerepe



Sejtek, sejtcsoportok gyűjtése lézerdisszekciós módszerrel

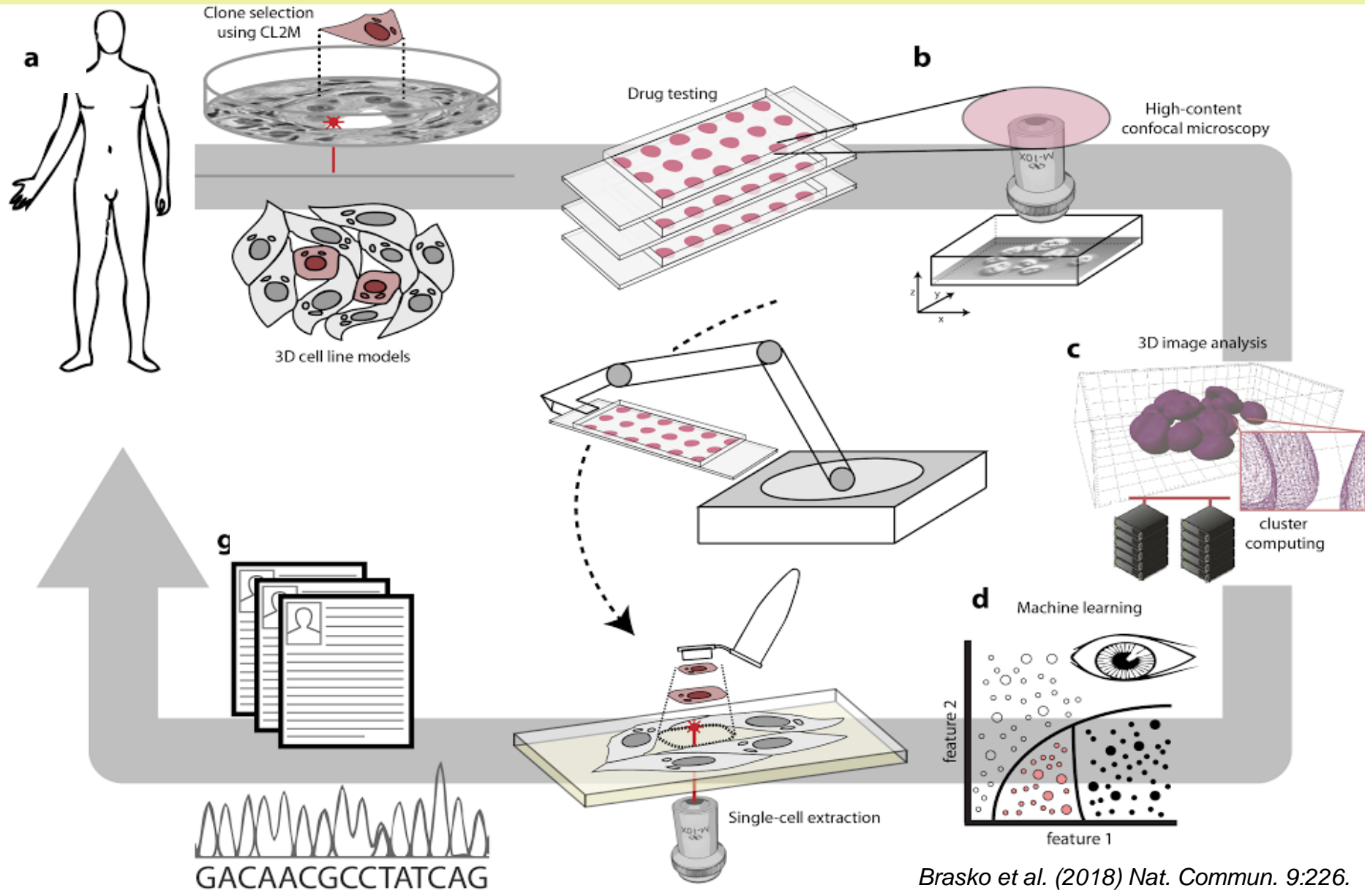

Különböző neuron típusok gyűjtése fixált, jelölt mintákból

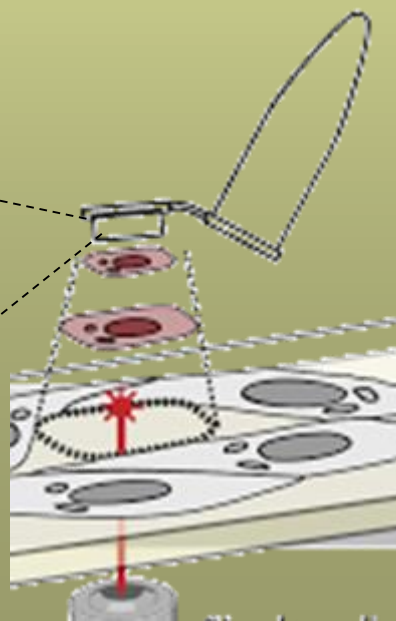
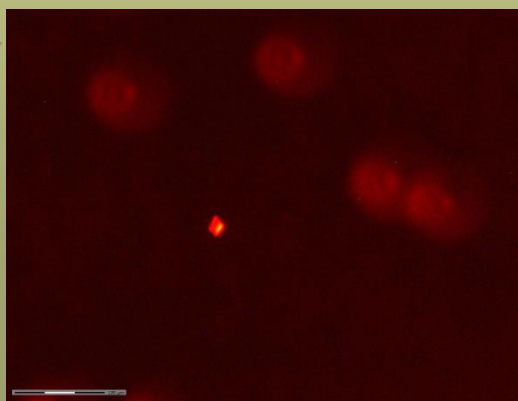
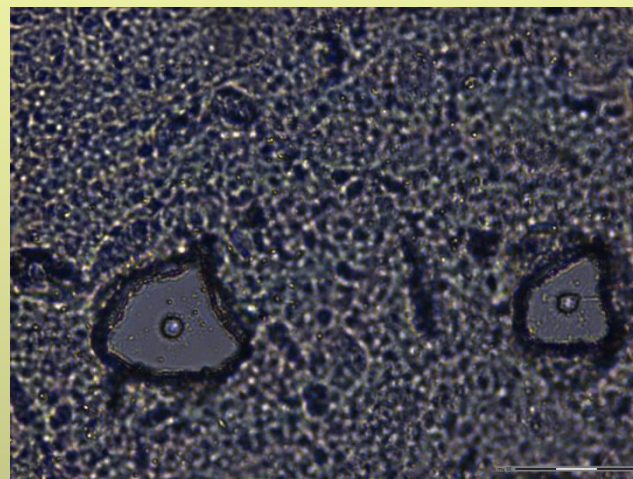
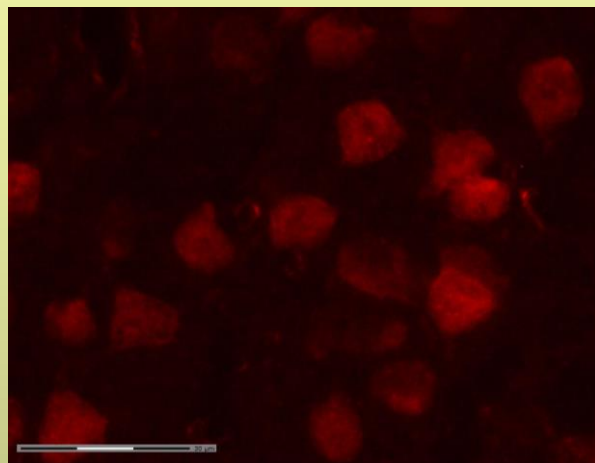

Tamás Gábor
Nagy István
kollaboráció

Genomi átrendeződések és változások vizsgálata csiptechnikával

Pontmutációk (SNP) detektálása

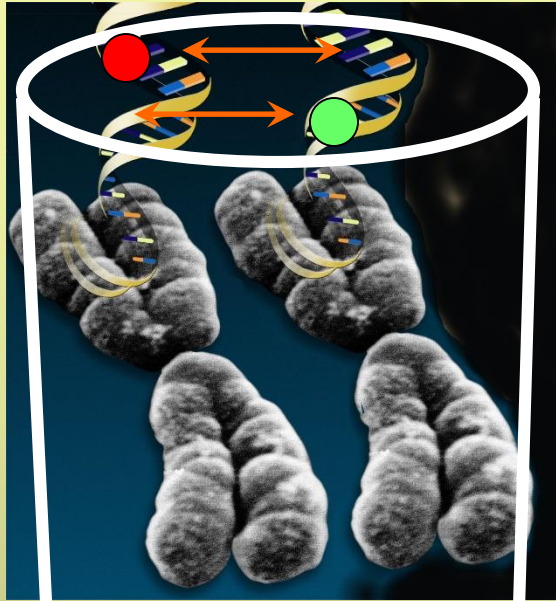

CCATGG
Vad típus

CCCTGG
Mutáns

1. SNP

GCTACC
Vad típus

GTTACC
Mutáns

2. SNP

- Oligonukleotid alapú chip
- egy nukleotid eltérés azonosítása

Jelölt DNS



hibridizáció



mosás



DNS

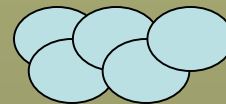

1. SNP
3 pozíció

2. SNP
2 pozíció

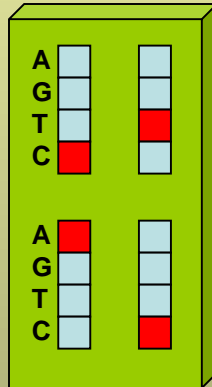

detektálás



Adat analízis

1. SNP: 3. pozíció A-C

2. SNP: 2. pozíció C-T

Genomszintű változások,
kromoszóma rendellenességek,
amplifikációk, deléciók detektálása

Paraffinba ágyazott minták

normál

daganat



PCR

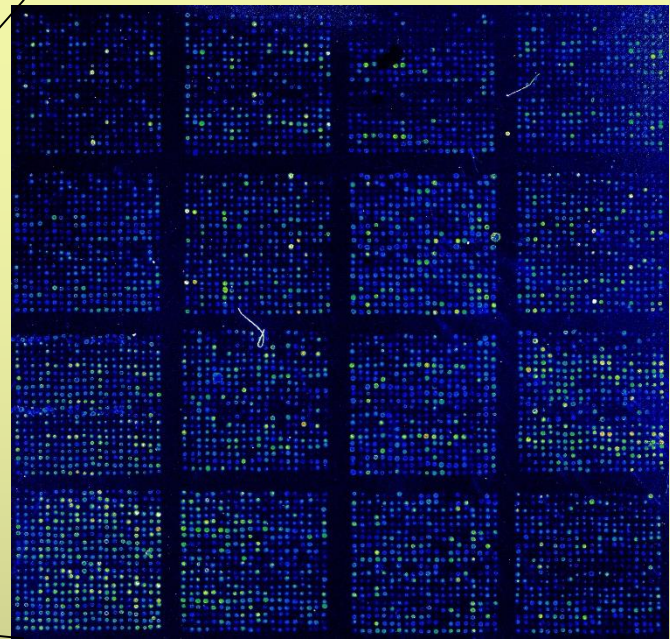

Metasztázisok, tumorok, multiplex tumorok jellemzése, igazolása

Génátrendeződési arányok

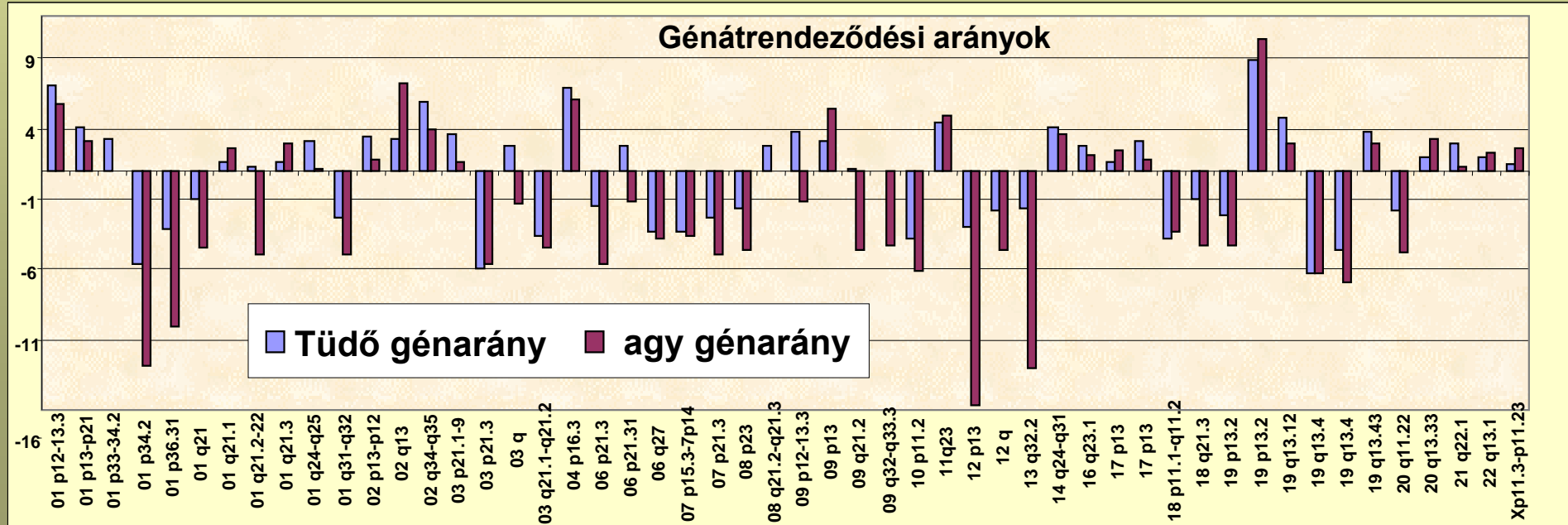

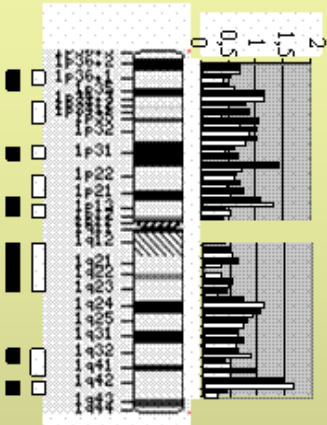

Chr1

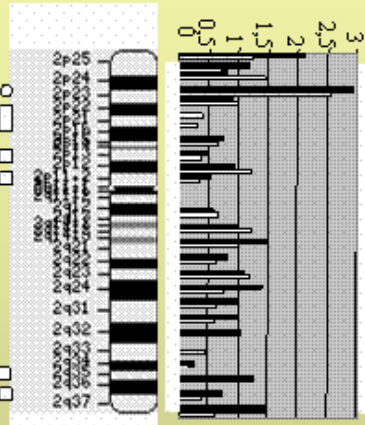

Chr2

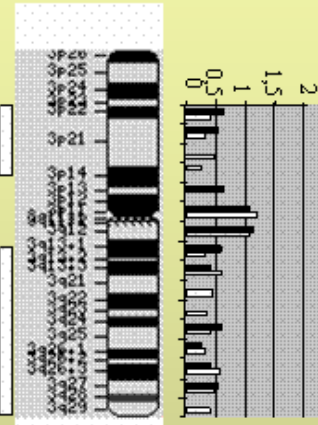

Chr3

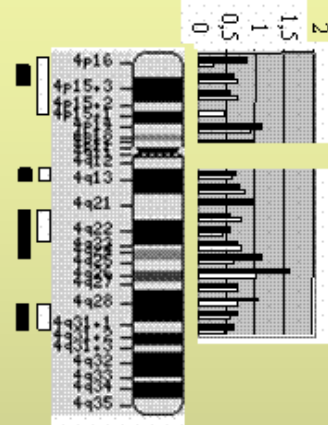

Chr4

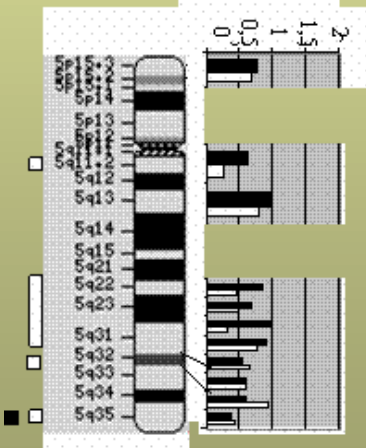

Chr5

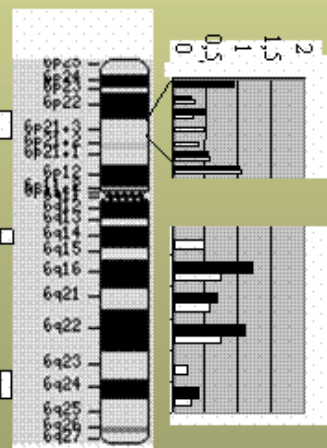

Chr6

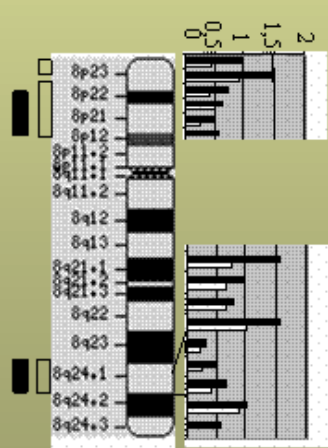

Chr8

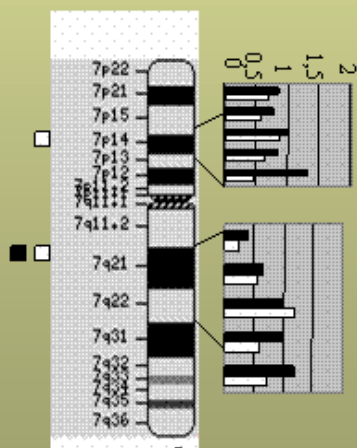

Chr 7

CGH nagyfelbontású (385K) *teljes genom array-vel*

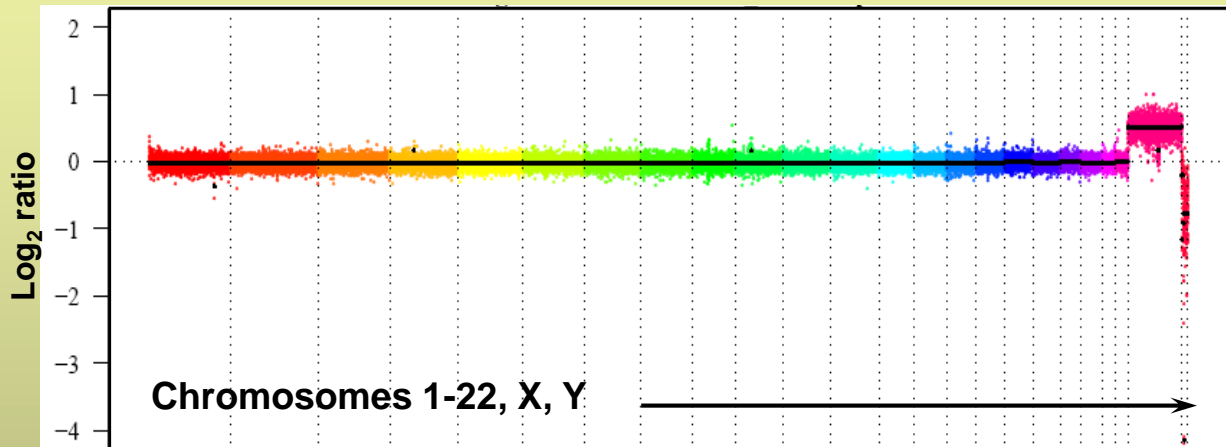

Nő vs. férfi gDNS

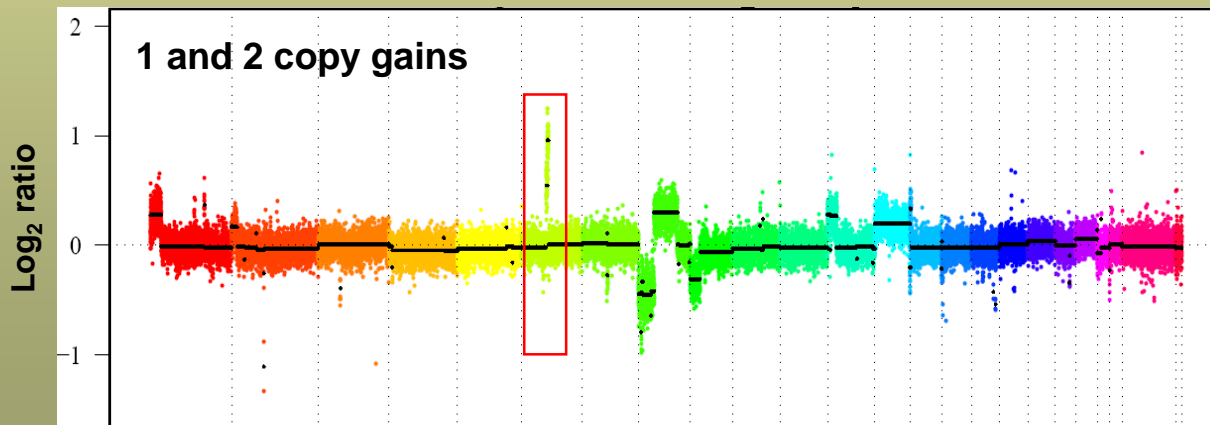

Pajzsmirigy tumor

Variation in copy number mapping to chr 17

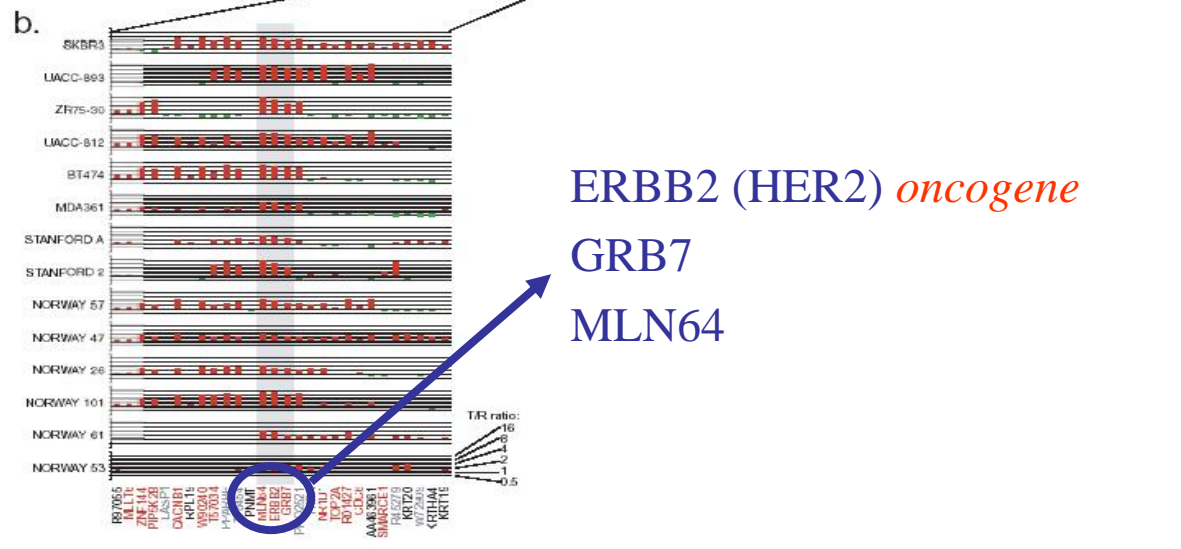
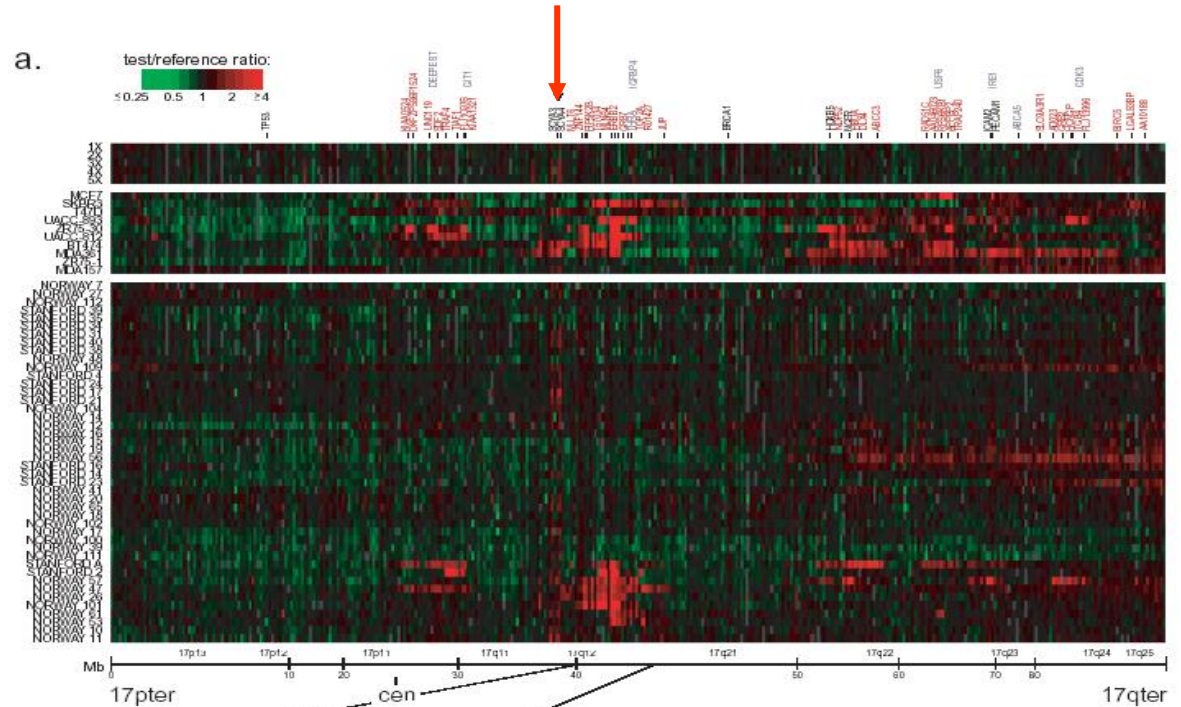

Párhuzamos mRNS szint vizsgálat

- 117 high level DNA amplifications (91 different genes)
- 62% (54 genes) found associated with at least moderately elevated mRNA
 - 12/54 genes are oncogenes or candidates
- 42% (36 genes) found associated with highly elevated mRNA.

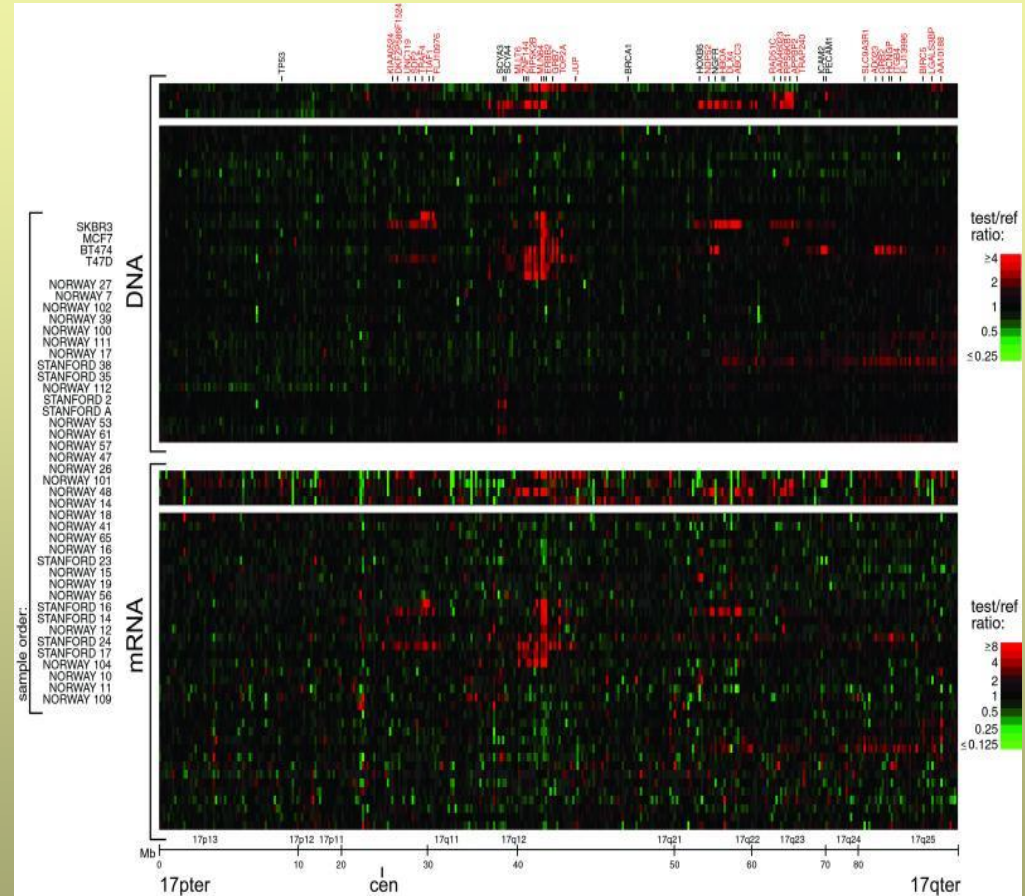

Egyedi genomi eltérések detektálása?

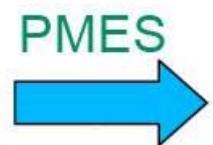
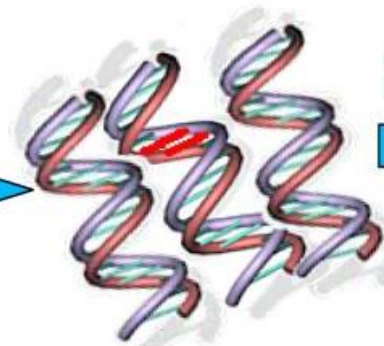
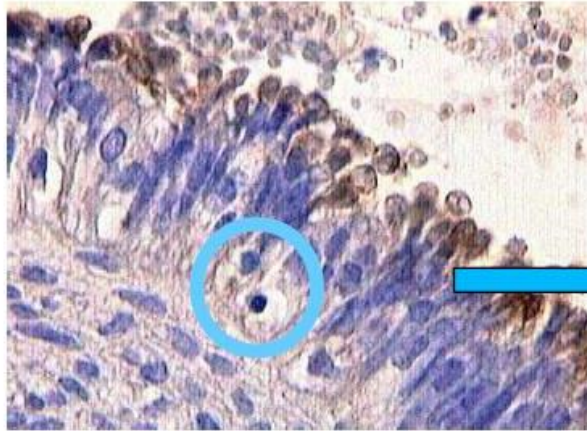

AGC TCC CGG TAC
AGC TCC **G**GG TAC
AGC TCC TGG TAC
AGC TCC **A**GG TAC

Drug resistance

KRAS mutaton correlates with resistance to e.g. Erbitux

Újgenerációs szekvenálási stratégiák

Loss of heterogeneity in the entire genome verification of haploidy by next generation sequencing

Reference Position	Variation Type	Length	Reference	Variants	Allele Variations	Frequencies	Counts	Coverage	Overlapping Annotations
220	SNP	1	A	1	G	100	259	259	rRNA: 12S ribosomal RNA, Gene: Rnr1
247	SNP	1	T	2	A/T	98.2/1.8	382/7	389	rRNA: 12S ribosomal RNA, Gene: Rnr1
348	SNP	1	T	1	C	100	169	169	rRNA: 12S ribosomal RNA, Gene: Rnr1
467	SNP	1	G	1	A	100	30	30	rRNA: 12S ribosomal RNA, Gene: Rnr1
482	SNP	1	C	1	T	100	201	201	rRNA: 12S ribosomal RNA, Gene: Rnr1
518	SNP	1	C	1	T	98.3	118	120	rRNA: 12S ribosomal RNA, Gene: Rnr1
569	SNP	1	T	1	C	100	171	171	rRNA: 12S ribosomal RNA, Gene: Rnr1
572	SNP	1	A	1	C	100	225	225	rRNA: 12S ribosomal RNA, Gene: Rnr1
646	SNP	1	T	1	C	98.4	183	186	rRNA: 12S ribosomal RNA, Gene: Rnr1
654	SNP	1	T	1	C	100	41	41	rRNA: 12S ribosomal RNA, Gene: Rnr1
815	SNP	1	A	1	T	100	73	73	rRNA: 12S ribosomal RNA, Gene: Rnr1
829	SNP	1	C	1	T	99.7	348	349	rRNA: 12S ribosomal RNA, Gene: Rnr1
900	SNP	1	C	1	T	99.7	385	386	rRNA: 12S ribosomal RNA, Gene: Rnr1
980	SNP	1	T	1	C	97.8	177	181	rRNA: 12S ribosomal RNA, Gene: Rnr1
1400	SNP	1	T	1	C	99.3	267	269	rRNA: 16S ribosomal RNA, Gene: Rnr2
1403	SNP	1	T	1	C	99.6	282	283	rRNA: 16S ribosomal RNA, Gene: Rnr2
1425	SNP	1	T	1	A	96.6	84	87	rRNA: 16S ribosomal RNA, Gene: Rnr2
1447	SNP	1	G	1	A	100	136	136	rRNA: 16S ribosomal RNA, Gene: Rnr2
1453	SNP	1	A	1	T	97.3	73	75	rRNA: 16S ribosomal RNA, Gene: Rnr2
1868	SNP	1	C	1	T	100	74	74	rRNA: 16S ribosomal RNA, Gene: Rnr2
1942	SNP	1	C	1	A	100	151	151	rRNA: 16S ribosomal RNA, Gene: Rnr2
1954	SNP	1	A	1	C	98.6	139	141	rRNA: 16S ribosomal RNA, Gene: Rnr2
1994	SNP	1	A	1	C	98.8	85	86	rRNA: 16S ribosomal RNA, Gene: Rnr2
2078	SNP	1	G	1	A	99.8	412	413	rRNA: 16S ribosomal RNA, Gene: Rnr2
2391	SNP	1	T	1	C	100	169	169	rRNA: 16S ribosomal RNA, Gene: Rnr2
2461	SNP	1	T	1	A	99.8	958	960	rRNA: 16S ribosomal RNA, Gene: Rnr2
2514	SNP	1	C	2	T/C	98.8/1.2	726/9	735	rRNA: 16S ribosomal RNA, Gene: Rnr2
2542	SNP	1	A	1	G	99.4	694	698	rRNA: 16S ribosomal RNA, Gene: Rnr2
2564	SNP	1	C	1	T	100	289	289	rRNA: 16S ribosomal RNA, Gene: Rnr2
3737	SNP	1	A	2	A/T	92.5/7.5	86/7	93	Gene: Trni, tRNA: Trni
3850	SNP	1	C	1	T	100	126	126	Gene: Trnm, tRNA: Trnm
7698	SNP	1	C	1	T	100	70	70	Gene: Trnk, tRNA: Trnk
8613	SNP	1	C	1	A	100	336	336	Gene: COX3, CDS: COX3
8622	SNP	1	C	1	T	100	378	378	Gene: COX3, CDS: COX3

Egyedi sejtek genomi és digitális expresszióvizsgálata

Elektrofiziológiailag különböző sejtek teljes genom analízise

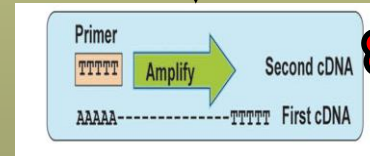
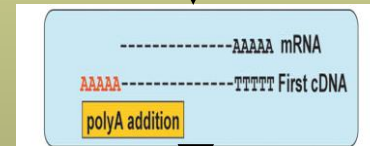
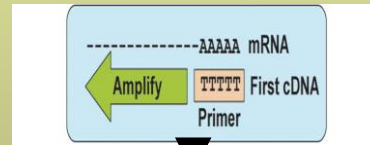
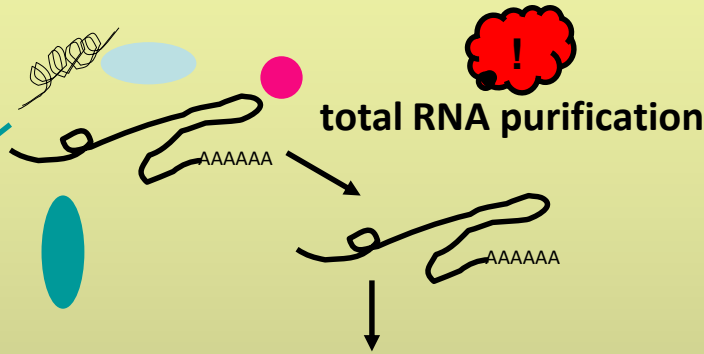
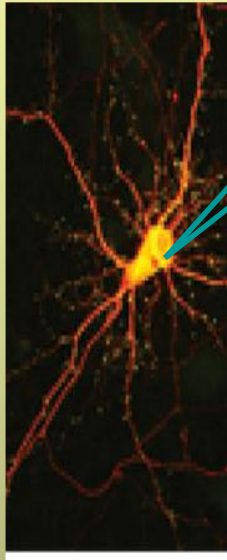

mRNA was amplified by a global polyadenylated PCR-based method

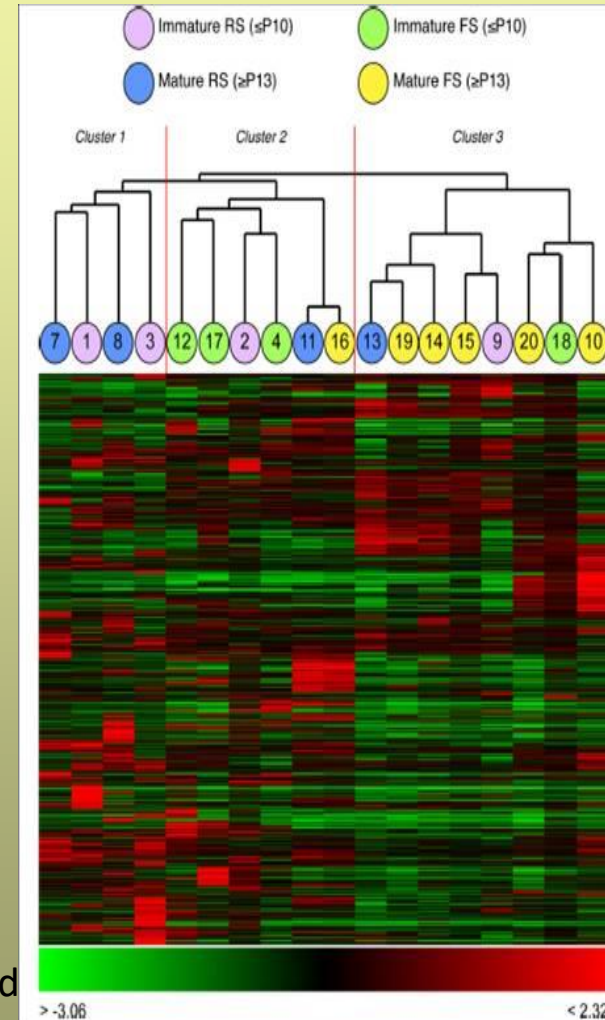

Grouping and classifying electrophysiologically defined classes of neocortical neurons by single cell, whole-genome expression profiling

Tatiana Subkhankulova, Kojiro Yano, Hugh P. C. Robinson and Frederick J. Livesey
 MOLECULAR NEUROSCIENCE, 2010

Elektrofiziológiailag különböző sejtek teljes genom analízise

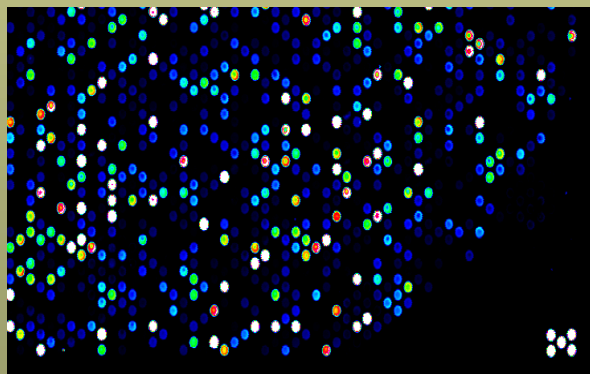
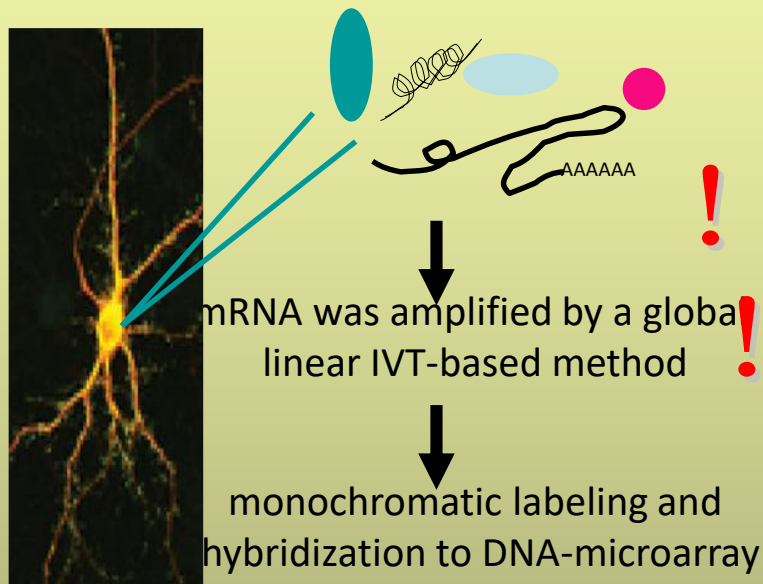

Type I interneuron

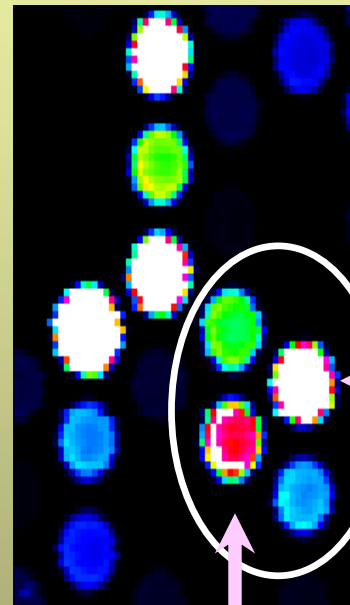

Type II interneuron

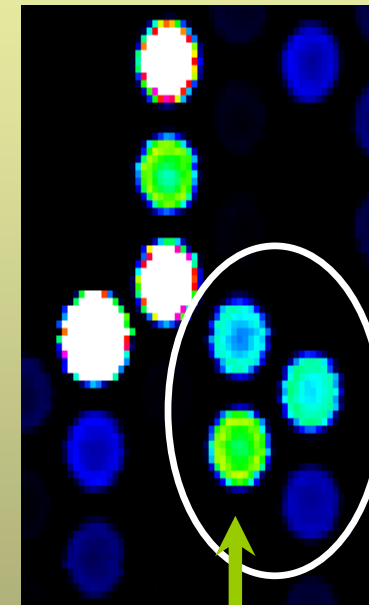

Gábor Tamás, Ágnes Katalin Kocsis, Szeged University
Nóra Faragó, Ágnes Zvara, HAS BRC, Szeged, Hungary

Digitális PCR – A PCR harmadik generációja

1.



PCR
Kvalitatív

2.

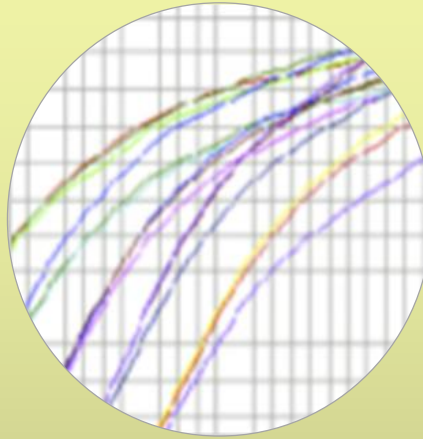

Real-time PCR
Relatív kvantitálás

3.

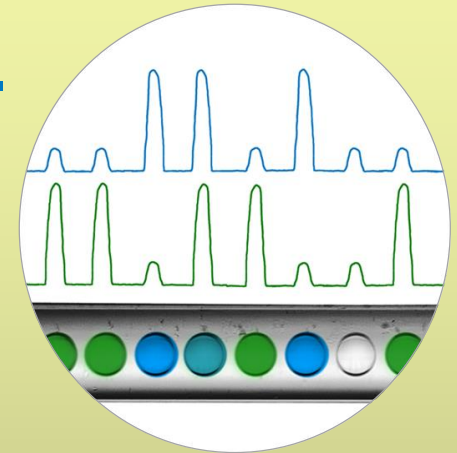

Digitális PCR
Abszolút kvantitálás

Végpont analízis

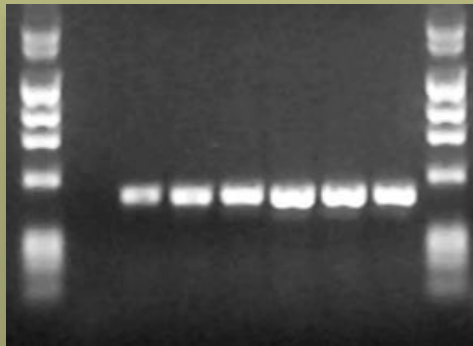

Fluoreszcencia detektálása

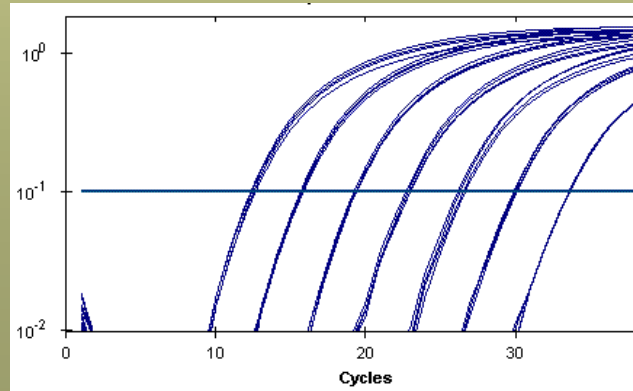

Egyedi reakciók elemzése

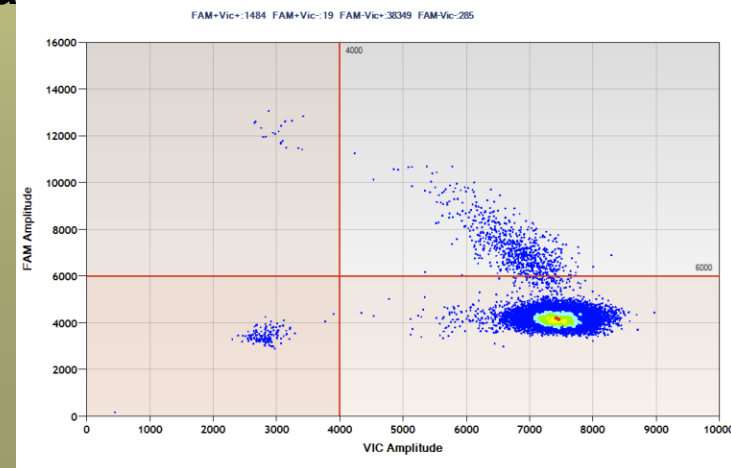

Digitális PCR nanokapilláris HTS QRT-PCR technikával

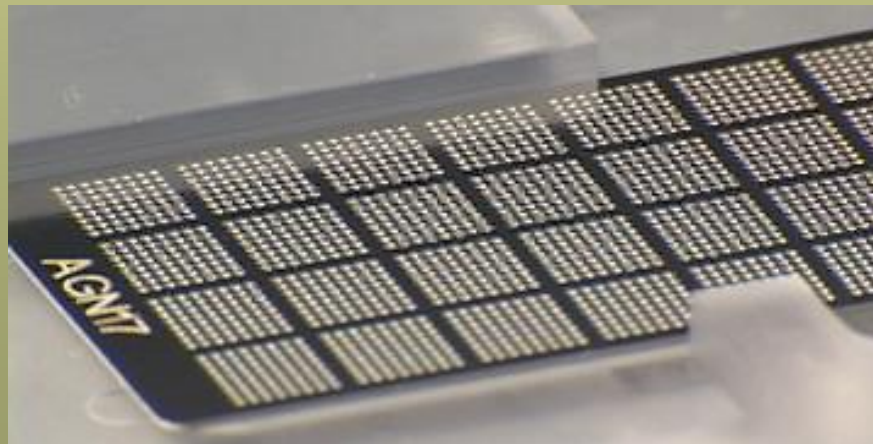
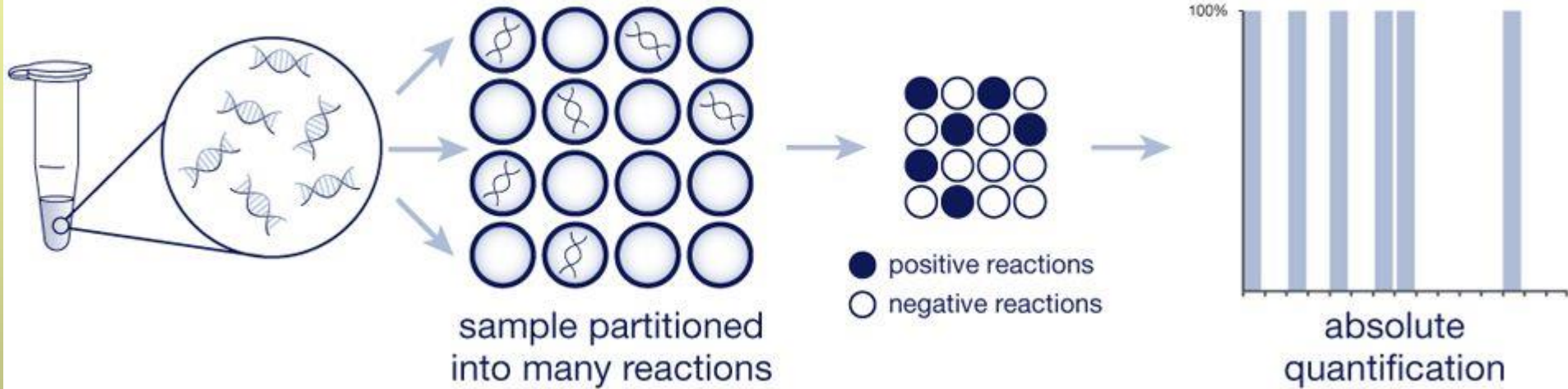



minta (1 sejt)
TaqMan próba
QRT-PCR reagens

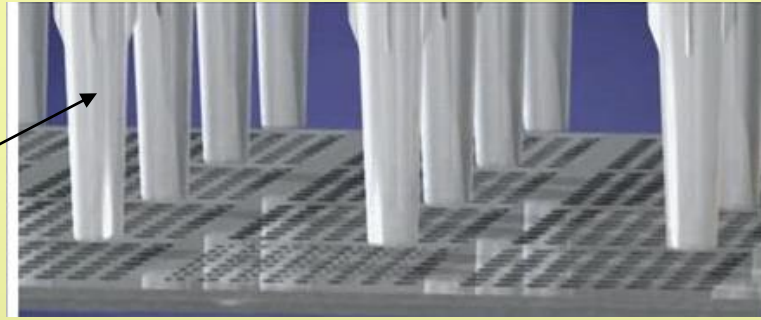

feltöltés

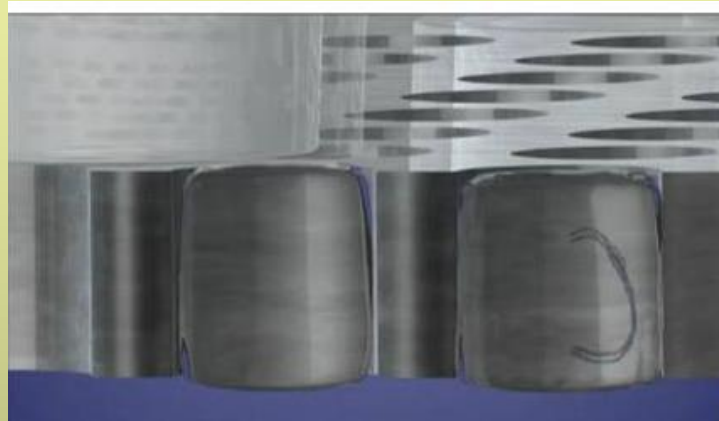

PCR

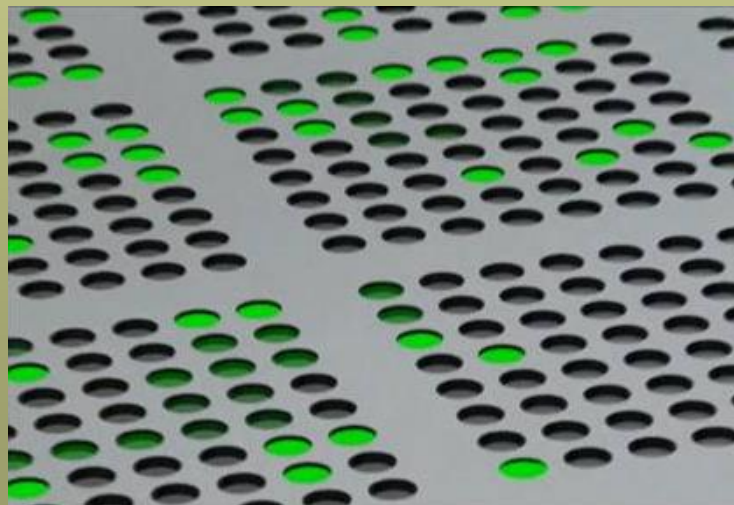

PCR vége

Spike-in DNS kópiaszámának meghatározása dQRT-PCR technikával

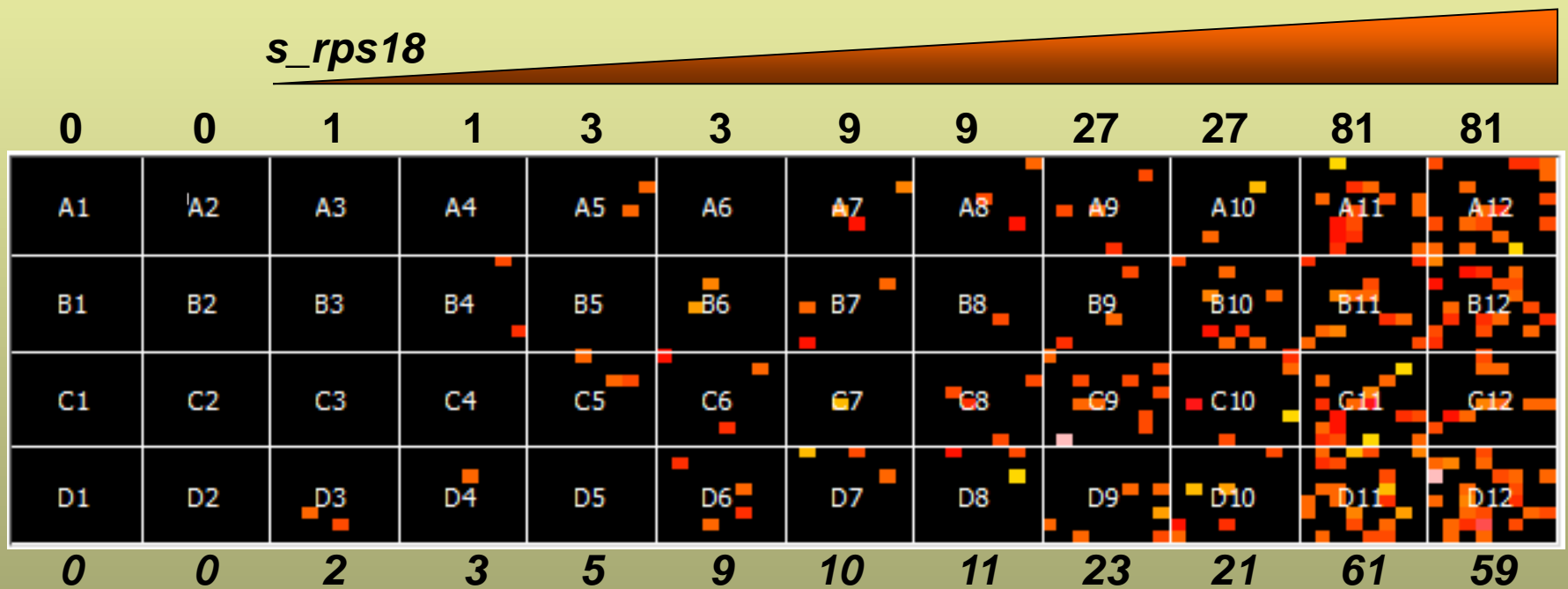

Egyedi neuronok génexpressziós elemzése digitális QRT-PCR módszerrel

Kísérlet tervezése

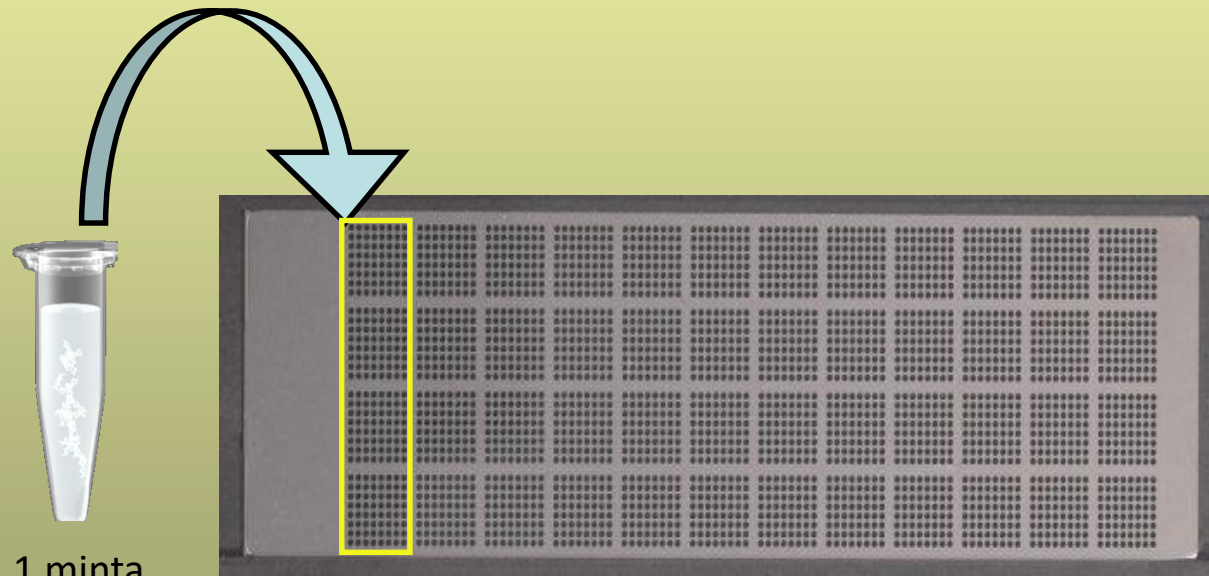

1 minta

4x64 = 256 egyedi PCR

Egyedi neuronok génexpressziós elemzése digitális QRT-PCR módszerrel

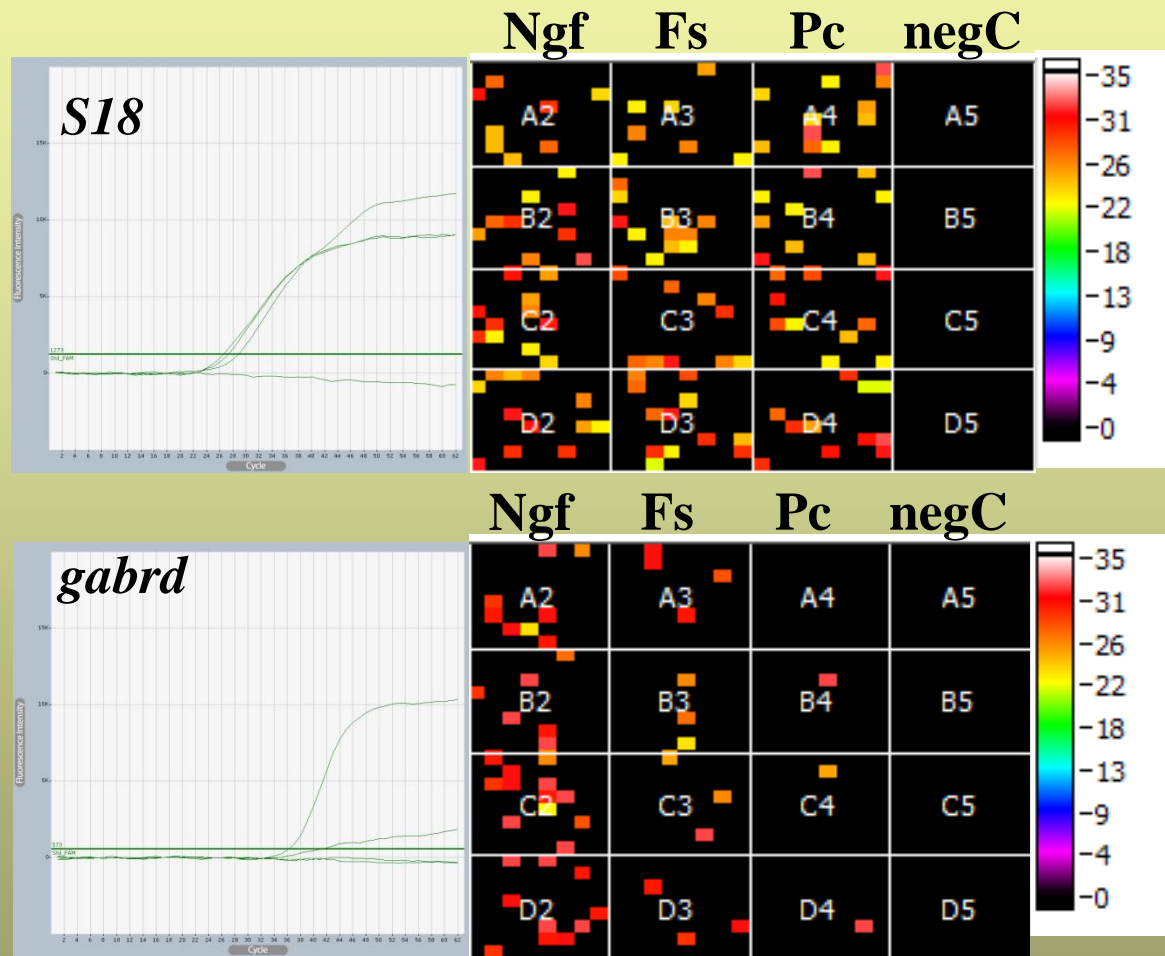

Ngf: Neurogliaform sejt

Fs: Fast spiking sejt

Pc: Piramis sejt

negC: RT- negatív kontroll

S18 háztartási gén hasonló kifejeződése minden neuron típusban

Neuron-típus specifikus expresszió: GABA receptor

Inzulin mRNS kópiaszám meghatározása egyedi sejtekben

Single cell digital PCR

hypoglycemia / normoglycemia

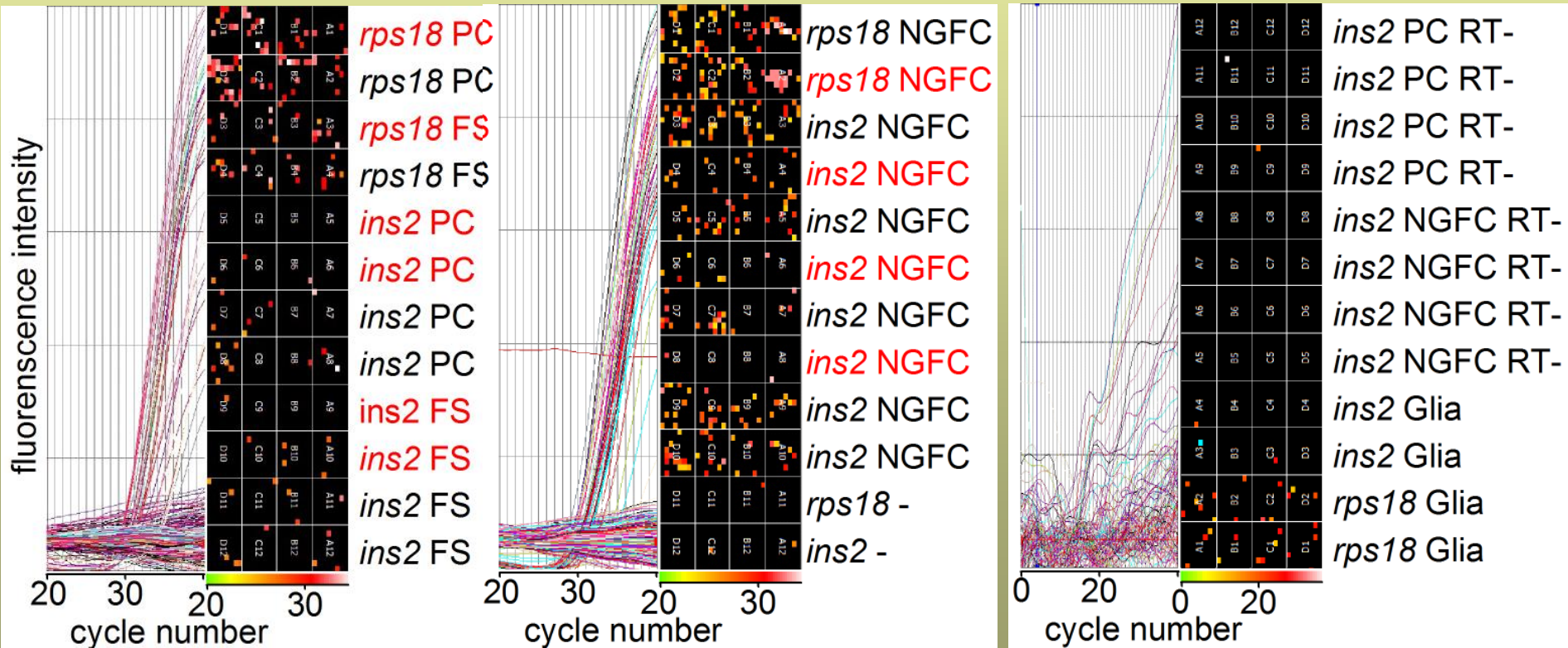
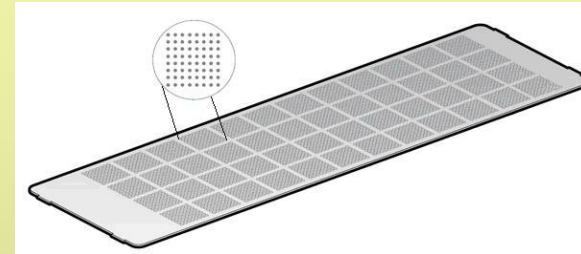

Hagyományos és chip adatok egy adott klinikai kórképre

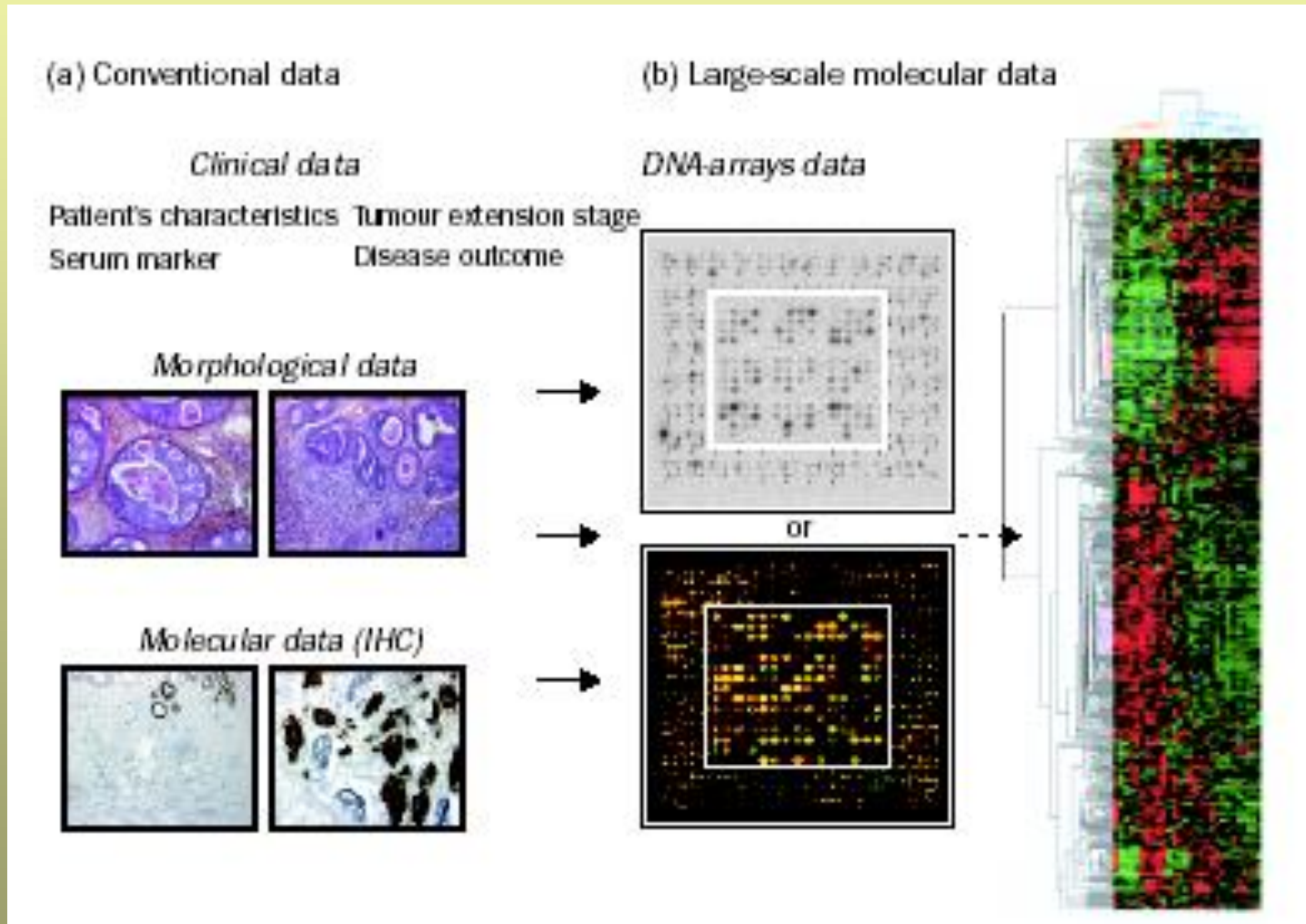

Köszönöm a figyelmet!

